

C-Bus®

Product Overview Catalogue

CLIPSAL®

by Schneider Electric

Innovative control solutions Commercial or residential environments



clipsal.com

INTEGRATED SYSTEMS

Clipsal Integrated Systems

Overview

Established in 1920, Clipsal by Schneider Electric is Australia's number one brand of electrical products, accessories and solutions for the residential, commercial, industrial, data, home control and energy management markets. Clipsal has evolved and grown from its Adelaide base with great success by supporting the local economy and providing products manufactured at multiple sites across Australia. Clipsal is an electrical industry leader, dedicated to supplying you with the most innovative and sustainable solutions available. As part of Schneider Electric, the global specialist in energy management, Clipsal provides a total electrical solution for any project or application.

As a company and brand, Clipsal has continuously developed and evolved to meet the needs of commercial and domestic building electrical requirements. Development in building automation products led to the formation of CIS (Clipsal Integrated Systems) in 2000, a business unit specialising in the manufacture of electronic lighting control and building automation products. Since then CIS has grown rapidly, gaining widespread acceptance in major commercial and domestic markets.

Through extensive research and design, CIS developed the C-Bus® Energy and Lighting Management System in 1994, and since then C-Bus has become the cornerstone of the CIS product range. Initially, C-Bus was designed and manufactured for commercial building applications. However, due to increasing worldwide interest, C-Bus was adapted to suit the domestic market with the release of C-Bus DIN Rail Series and associated products.

With the development of C-Bus for domestic application, a new generation of products was born, including the C-Touch™ Touch Screen Controllers, Neo® Wall Switches, and Saturn™ Wall Switches.

CIS continue to set new precedents by expanding the C-Bus range. Introducing products such as the modular Architectural and Professional ranges of high powered dimmers, C-Bus Wireless Technology, Dynamic Labelling Technology (DLT™), C-Bus Multi-Room Audio System and Wiser™ Home Control. Not only is the C-Bus product range extensive, but it also complies with international product certification requirements such as the C-Tick, CE and UL marks. All C-Bus products are developed to be backward compatible to ensure extensions of existing installations are easy, and capable of engaging these future technologies. C-Bus also assists with energy management through the control of lighting and electrical products to only use energy when required.

CIS have also recognised the changing requirements for control systems in commercial buildings, particularly with regards to the need to provide clients with one integrated control solution. CIS have created interface platforms for C-Bus, such the BACnet Gateway, DALI Gateway and OPC Server, to meet this integrated solution need.

CIS is committed to ensuring the end-user gets the most out of every C-Bus system. To assist in meeting this commitment, CIS has created the following C-Bus installer programs.



C-Bus® Platinum Program

The aim of the C-Bus Platinum Program is to link Clipsal clients who have a commercial building project to a network of professionals who are able to successfully deliver a complete C-Bus Control and Management System, including integration to other building services. From design to integration, installation and programming, C-Bus Platinum partners can assist commercial developers, consultants and designers throughout the project delivery process. This ensures a smooth delivery process with the highest quality C-Bus installation for your commercial building.



C-Bus® pointOne Program

C-Bus® pointOne is a group of specialist systems integration companies that have the technical knowledge and practical experience on a whole range of complementary technologies to enhance the functionality of your residential premises. The one point of contact, C-Bus pointOne members make residential lighting control and automation applications an easier process. They do this by providing turnkey solutions for the design, project management, installation, integration, programming and support of Clipsal C-Bus, as well as integration with products from third party manufacturers.

C-Bus pointOne members are accredited integration professionals, who have been trained in all aspects of the Clipsal C-Bus system, with some having over 30 years of industry experience.



C-Bus® Approved Installer Program

C-Bus® Approved Installers have been trained and accredited by Clipsal as specialists in C-Bus technology and its application. This is the first stage in the C-Bus accreditation process and can lead to pointOne or Platinum partner status.

From system design through to installation, then on to programming and commissioning, a C-Bus Approved Installer will ensure that your C-Bus system reaches its full potential, delivering the best performance, functionality and, most of all, value for money.

Any building, whether it's a home or a commercial site, is a big investment. Don't risk compromising the outcome with just anyone. Insist on a C-Bus Approved Installer and get confidence and peace of mind in knowing that you have the backing of Clipsal, Australia's number one in electrical building products.

Clipsal C-Bus

Overview

Introduction

The Clipsal C-Bus system is a microprocessor based wiring system to control lighting and other electrical services.

From ON/OFF control of a lighting circuit to analogue type control, such as dimming electronic fluorescent ballasts, C-Bus can control and automate virtually any type of electrical load.

C-Bus information is held within individual C-Bus units rather than one central point. This ensures optimum communications speed and reliability.

To ensure fast and reliable operation, each device has its own in-built microprocessor, which can be individually programmed via 'point and click' PC-based software, or via 'Learn Mode' which doesn't require a PC.

While a computer is unnecessary for normal C-Bus operation, C-Bus PC-based control and management software is available and provides additional flexibility to clients requiring this type of control.

Clipsal C-Bus is suitable for a wide range of applications.

Commercial Lighting Control

- Fluorescent lighting control for energy cost savings in high rise buildings.
- Integration with occupancy sensors and daylight level sensors, for energy efficiency.
- High-bay control in warehouses for energy cost saving.
- Integration with BMS to provide a more comprehensive lighting control solution.

Mood Lighting in Restaurants and Retail Outlets

- Flexible and integrated control of lighting and audiovisual equipment in boardrooms. Architectural lighting control for hotel foyers, ballrooms, art galleries and museums.

Standalone Room Control

- Integrated automation via touch screen user interfaces. For conference rooms and home theatres.
- Multiple scene/mood setting.

Residential Home Control

- Home entertainment - Integrated audiovisual, lighting control and other electrical services.
- Security - Integrated security, lighting and other electrical services.
- Comfort – Dimming, scene setting, etc.
- Convenience – Multiple point control, central point control from touch screens, automated time-based control, automated 'Goodbye' and 'Welcome Home' scenes.
- Energy efficiency – Incorporation of light level sensors, occupancy control, temperature sensors and much more to assist your home to operate more efficiently.

C-Bus Network Design Considerations

- Up to 1000m of C-Bus Cat. 5 UTP cable may be connected to a single C-Bus network
- Up to 100 C-Bus units may be connected to a single C-Bus network
- Where more than 1km and/or 100 standard C-Bus units are required, two or more networks can be created and linked with C-Bus Network Bridge and/or C-Bus Ethernet Interface Units
- Maximum number of networks in one installation is 255 (this limitation does not apply if a C-Bus Ethernet interface is utilised, the system size is then limited to IP addressing only)
- Maximum number of networks connected in series to the local network via Network Bridges is seven (i.e. using six network bridges)
- Each standard C-Bus unit requires 18mA @ 36V d.c. to operate correctly. Some C-Bus units, for example 5500PC, require 32mA. Some C-Bus units, for example L5508DIA, are self-powering and do not sink current from the 36V d.c. C-Bus network
- More than one C-Bus power supply can be connected to a C-Bus network to provide sufficient power to the C-Bus units. The C-Bus power supplies will share the load evenly. Maximum total power supply allowed is 2,000mA (2A)
- Any combination of power supply units is allowed as long as the total power available is 2,000mA or less
- Each C-Bus network requires only one network burden. This network burden is software selectable on C-Bus output units
- Each C-Bus network requires at least one system clock-generating unit (for data synchronisation)
- C-Bus power supply units may be connected to different phases
- Individual relay channels may be connected to different phases
- On L5508D1A and L5504D2A units the mains supply to the units power supply and the mains supply to the output channels must be on the same phase
- The isolation between the mains supply circuitry and the 36V d.c. C-Bus circuitry is greater than 3.75kV. This is achieved using double wound transformers and opto isolators. This means the C-Bus wiring, connections and circuitry can be considered extra low voltage
- C-Bus Cat. 5 UTP cable has mains rated sheathing, which means the C-Bus cable can be taken inside electrical distribution boards, provided segregation requirements of local wiring standards are met
- The following are control methods that provide a number of options when either manual or override control of electrical loads connected to a C-Bus network is required:
 - Manual toggle of output channels using the manual override buttons on output units
 - Remote ON/OFF override of a C-Bus network using standard 30 mechanism switches
 - Auto remote ON override of a C-Bus network using the C-Bus Network Monitor (5500NMA)
- All C-Bus output units consist of electronic components that may be damaged by surges, short circuits and over-voltages. All equipment should have over-current protection relevant to installed equipment and cable size, and surge protection fitted.

Contents

- **Page 8**

C-Bus Input Units
Wall Switches, General Input Units, Passive Infrared Motion Detectors, Infrared Receivers, Remote Controls, Touch Screen Controllers

- **Page 46**

C-Bus Output Units
Architectural Dimmers, Professional Dimmers, DIN Rail Dimmers, Infrared Output Units, DIN Rail Relay Units, Standard Relay Units

- **Page 70**

C-Bus System Units and Accessories
Wiser Home Controller, Power Supply, Network Bridge, Network Interface, Gateways

- **Page 82**

C-Bus Software
Commissioning Tools, User Interfaces, Gateways and Drivers

- **Page 88**

C-Bus Multi-Room Audio
Matrix Switcher, Zone Amplifiers, Speakers

- **Page 98**

C-Bus Wireless
Wall Switches, Plug Adaptors, Remote Controls, Wireless Gateway

- **Page 120**

C-Bus HomeSafe Security Interface

- **Page 122**

C-Bus Typical Schematics

Wall Switches



Environment Sensors



General Input Units



Occupancy Sensors



Handheld IR Remotes



Touch Screen Controllers



Professional Dimmers



DIN Rail Dimmers



DIN Rail Relays



Extra Low Voltage Relay



Infrared Transmitters



Controllers



Network Support Devices



Gateways



Commissioning Tools



Graphical User Interfaces



Gateways and Drivers



Matrix Switcher



Amplifiers



Speakers



Wall Switches



Plug Adaptors



Handheld Remotes



Gateways



C-Bus HomeSafe Security Interface



C-Bus Input Units

Wall Switches

C-Bus Enhanced Dynamic Labelling Technology (eDLT) Wall Switch

- Quick and easy installation
- Plug-in C-Bus fly lead
- Magnetic attachment to a custom mounting plate installed to standard mounting hardware (with 84mm centres)
- Can be secured to mounting plate with screws
- Proximity sensing for wake up and control functions (max. 5cm)
- 5 buttons with tri-colour LED indicators
- Backlit colour LCD screen
- 2.8" WQVGA TFT screen supports selected number of background and foreground colours
- Coloured LED indicators or backgrounds can provide status feedback for C-Bus events such as power monitoring or security system state
- Up to 4 pages with control of up to 16 devices
- 5-button single-page option
- Dual-action buttons provide intuitive control with left/right rocking action
- Use 1 dual-action button for easy UP/DOWN control of:
 - o lighting levels
 - o audio volume, bass and treble levels
 - o motorised blinds, shutters, curtains, etc.
- Use 1 dual-action button for easy LEFT/RIGHT control of:
 - o ceiling sweep fans
 - o scene cycling
 - o page navigation
 - o C-Bus Multi-Room Audio source selection and radio station selection.
- Native support for C-Bus Audio and C-Bus Measurement Applications:
 - o enhanced performance with C-Bus Multi-Room Audio
 - o display temperature from C-Bus Digital Temperature Sensor
 - o display power usage and other text-based information.
- Range includes both Saturn and Neo fascia styles:
 - o Saturn glass and metal fascias
 - o Saturn style with either Black or White grid
- Room Courtesy Panel option utilising custom-made button caps
- Comprehensive "Tools" page allows a user to:
 - o edit button labels
 - o edit timer durations
 - o change time and date settings
 - o modify LED indicator on/off colours
 - o modify screen background and foreground colours.
- Supports extended character sets for many languages
- Field upgradeable firmware
- C-Bus Toolkit programming enhancements
 - o WYSIWYG (what you see is what you get) interface
 - o Intelligent algorithm improves programming time
- Fly lead and mounting plate are supplied with the eDLT and are also available separately



5085EDLW-PW
Wall Switch,
5-Button, eDLT

Pictured: Pure White



5085EDLB-SS
Wall Switch,
5-Button, eDLT

Pictured: Stainless
Steel



5000CBF
Plug-in C-Bus Fly
Lead Terminal



5085EDLB-OM
Wall Switch,
5-Button, eDLT

Pictured: Ocean
Mist



5085EDLB-HB
Wall Switch,
5-Button, eDLT

Pictured: Horizon
Black



5000MP
Mounting Plate
to suit eDLT Wall
Switch



5085EDLB-EB
Wall Switch,
5-Button, eDLT

Pictured: Espresso
Black

AVAILABLE COLOURS

eDLT - Saturn Series

- Saturn Pure White (5085EDLx-PW)
- Saturn Ocean Mist (5085EDLx-OM)
- Saturn Espresso Black (5085EDLx-EB)
- Saturn Cream* (5085EDLx-CM)
- Saturn Mid-Brown (5085EDLx-BR)
- Saturn Stainless Steel (5085EDLx-SS)
- Saturn Horizon Black (5085EDLx-HB)

eDLT - Neo Series

- Neo White (5055EDL-WE)
- Neo Black (5055EDL-BK)
- Neo Battleship Grey/Brushed Aluminium (5055EDL-GB)

Note: 'x' denotes Black (B) or White (W) grid. '**' denotes a product that is made to order.

C-Bus Input Units

Wall Switches

C-Bus Dynamic Labelling Technology (DLT) Wall Switches

- Available in Saturn and Neo styles
- Saturn units feature an impact resistant glass fascia available in Pure White, White, Black, Cream and Mid-Brown
- Saturn unit available with Stainless Steel fascia
- Neo units available in grey with Brushed Aluminium-look inner surround
- Units incorporate 8 buttons for C-Bus Group/Scene control over 2 pages (4 buttons per page)
- Page/Scroll button
- Each button can be programmed with ON/OFF toggle, dimmer, timer, scene control and custom functions
- LCD labelling for each button
- Text, sliders and bitmaps can be defined and downloaded to the unit via a C-Bus network.
- Dimmable blue LED on each button
- Night light on all buttons or just the bottom button
- 64 x 128 pixel LCD screen
- Dimmable white LED backlighting for the LCD
- Ignore first button press option
- Fall back to page 1 option
- Real-time clock display
- Programmed via C-Bus Toolkit software
- Draws 22mA from the C-Bus network
- C-Bus Learn Enabled

Neo Series



5055DL-WE
Wall Switch,
5-Button, DLT

Pictured: White



5055DL-GB
Wall Switch,
5-Button, DLT

Pictured: Battleship
Grey/Brushed
Aluminium

AVAILABLE COLOURS

DLT - Neo Series

- Neo White (5055DL-WE)
- Neo Battleship Grey/Brushed Aluminium (5055DL-GB)

Saturn Series



5085DL-GF
Wall Switch,
5-Button, DLT

Pictured: White



5085DL-PW
Wall Switch,
5-Button, DLT

Pictured: Pure White



5085DL-HB
Wall Switch,
5-Button, DLT

Pictured: Horizon
Black



5085DL-780
Wall Switch,
5-Button, DLT

Pictured: Mid-Brown



5085DL-680
Wall Switch,
5-Button, DLT

Pictured: Black



5085DL-J80
Wall Switch,
5-Button, DLT

Pictured: Stainless
Steel



5085DL-380
Wall Switch,
5-Button, DLT

Pictured: Cream

AVAILABLE COLOURS

DLT - Saturn Series

- Saturn White (5085DL-GF)
- Saturn Pure White (5085DL-PW)
- Saturn Mid-Brown (5085DL-780)
- Saturn Black (5085DL-680)
- Saturn Stainless Steel (5085DL-J80)
- Saturn Cream (5085DL-380)
- Saturn Horizon Black (5085DL-HB)

C-Bus Input Units

Wall Switches

C-Bus Saturn Wall Switches

- Impact-resistant glass fascia, available in Pure White, White, Black, Cream and Mid-Brown
- Available with Stainless Steel fascia
- 2, 4 or 6 buttons per wall switch
- Programmable as ON/OFF toggle, dimmer, timer, scene control and custom functions
- Selectable blue and orange LED indicator on each button configured through C-Bus Toolkit software
- LED button indicators provide illumination and status feedback
- Night light feature
- Fallback level option to dim indicators at a set time after the last button press
- Mounted using standard mounting accessories (ordered separately)
- Programmed via Learn mode or the C-Bus Toolkit software
- Draws 22mA from the C-Bus network
- C-Bus Learn Enabled



5082NL-J80
Wall Switch,
2-Button

Pictured: Stainless Steel



5084NL-PW
Wall Switch,
4-Button

Pictured: Pure White







5086NL-680
Wall Switch,
6-Button

Pictured: Black

AVAILABLE COLOURS

Saturn Series

-  Saturn Stainless Steel (508xNL-J80)
-  Saturn Pure White (508xNL-PW)
-  Saturn Black (508xNL-680)
-  Saturn White (508xNL-GF)
-  Saturn Cream (508xNL-380)
-  Saturn Mid-Brown (508xNL-780)

Note: 'x' denotes number of buttons: i.e. 2, 4 or 6 buttons.

C-Bus Saturn Wall Switches - Accessories



5080LC-8
Pre-Labelled Button Caps
(individually printed with
commonly used labels and
come in pack of 66)

Mounting Frames

This mounting frame accessory can be used in conjunction with C-Bus Saturn Wall Switches to provide an alternative look to the switch edge for blending in with the client's wall colour.



5850F-WE
Mounting Frame,
Rectangular,
White (pack of
5), suits 2-, 4- or
6-Button Wall
Switches.



1.



2.



3.

C-Bus Input Units

Wall Switches

C-Bus Modena Wall Switches

- Available in White (WH) and Black (BK)
- 2, 4 or 6 buttons per wall switch
- Programmable as ON/OFF toggle, dimmer, timer, scene control and custom functions
- Selectable blue and orange LED indicator on each button configured through C-Bus Toolkit software
- LED button indicators provide illumination and status feedback
- Night light feature
- Fallback level option to dim indicators at a set time after the last button press
- Mounted using standard mounting accessories (ordered separately)
- Programmed via Learn mode or the C-Bus Toolkit software
- Draws 22mA from the C-Bus network
- C-Bus Learn Enabled
- Suits Modena 8000 Series Surrounds



LHC882-WH
Wall Switch, 2-Button

Pictured: White



LHC884-BK
Wall Switch, 4-Button

Pictured: Black





LHC886-WH
Wall Switch, 6-Button

Pictured: White

AVAILABLE COLOURS

Modena Series

-  White (LHC88x-WH)
-  Black (LHC88x-BK)

Modena 8000 Series Surrounds

-  Platinum (M8000HC-PT)
-  Charcoal (M8000HC-CC)
-  Blue (M8000HC-DB)
-  Red (M8000HC-RD)
-  Champagne (M8000HC-CP)
-  Gunmetal (M8000HC-GM)
-  Chrome (M8000HC-CH)

Note: 'x' denotes number of buttons: i.e. 2, 4 or 6 buttons.

C-Bus Avanti Wall Switches

- Rockers are a long throw momentary action type ('spring return')
- Available in 1, 2 or 3 buttons per wall switch in White only
- Programmable as ON/OFF toggle, dimmer, timer, scene control and custom functions
- Selectable red and green LED indicator on each button configured through C-Bus Toolkit software
- LED button indicators provide illumination and status feedback
- Night light feature
- Fallback level option to dim indicators at a set time after the last button press
- Mounted using standard mounting accessories (ordered separately)
- Programmed via Learn mode or the C-Bus Toolkit software
- Draws 18mA from the C-Bus network
- C-Bus Learn Enabled



5091NL-WE
Wall Switch, 1-Button
Pictured: White



5092NL-WE
Wall Switch, 2-Button
Pictured: White



5093NL-WE
Wall Switch, 3-Button
Pictured: White

AVAILABLE COLOURS

Avanti Series

White (509xNL-WE)

Note: 'x' denotes number of buttons: i.e. 1, 2 or 3 buttons.

C-Bus Input Units

Wall Switches

C-Bus Neo Wall Switches

- Architecturally designed, modular C-Bus Wall Switches
- Optional rocker cover with ID window for labelling of buttons (ordered separately)
- Backlight for ID windows
- 2, 4 or 8 buttons per wall switch
- Integral infrared receiving window
- Programmed via C-Bus installation software or via the Learn mode features
- Programmed as dimmers, timers, ON/OFF toggle switches and scene switches (up to four scenes per unit)
- Selectable blue and orange button LEDs configured through C-Bus installation software
- Available as standard in Battleship Grey (GB), White Electric (WE), Cream (CM), Soft Grey (SG) and Black (BK)
- Night light feature
- Units use standard Australian mounting brackets and wall boxes
- Units draw 22mA from a C-Bus network
- C-Bus Learn Enabled

C-Bus Neo Wall Switches - Accessories



5052NL-GB
Wall Switch,
2-Button

Pictured: Battleship
Grey/Brushed
Aluminium

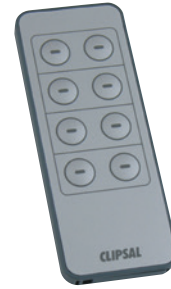

5038TX2
8-Button Handheld
Infrared Remote
Control for Neo
Switches (also suits
C-Bus 30M Wall
Switches, C-Bus
Multi-Sensor and
503xNIRL Series
Wall Switches)



5054NL-CM
Wall Switch,
4-Button

Pictured: Cream



5052NRI - GB
Neo Rocker Cover
with ID Window
(pack of 10)

Pictured: Battleship
Grey/Brushed
Aluminium



5058NL-WE
Wall Switch,
8-Button

Pictured: White

AVAILABLE COLOURS

Neo Series

-  Battleship Grey/Brushed Aluminium (505xNL-GB)
-  Cream (505xNL-CM)
-  White (505xNL-WE)
-  Soft Grey (505xNL-SG)
-  Black (505xNL-BK)

Note: 'x' denotes number of buttons: i.e. 2, 4 or 8 buttons.

C-Bus Input Units

Wall Switches

C-Bus Reflection Wall Switches

- Architectural, flat stainless steel C-Bus Wall Switches
- No visible screws
- 1, 2, 3, 4, 6 or 8 buttons per wall switch
- Available in brushed Stainless Steel
- Each button has an associated blue LED indicator providing feedback status
- Programmed as dimmers, timers, ON/OFF toggle switches and scene switches (up to 4 scenes per unit)
- Programmed via C-Bus installation software or via the Learn mode features
- A custom wall box is required to mount this switch, standard wall brackets and boxes cannot be used
- Units draw 22mA from a C-Bus network
- C-Bus Learn Enabled

C-Bus Reflection Wall Switches - Accessories



R5061NL
Wall Switch, 1-Button
Pictured: Stainless Steel

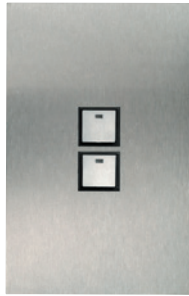

R5062VNL
Wall Switch, 2-Button
Pictured: Stainless Steel



R5060WB
Wall Box to suit Reflection Range of Wall Switches

Important note: Wall Box must be used to install Reflection Wall Switches.

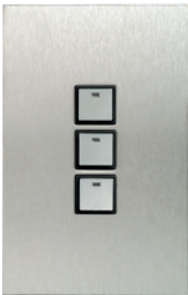

R5063NL
Wall Switch, 3-Button
Pictured: Stainless Steel

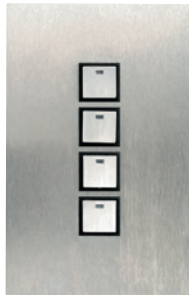

R5064VNL
Wall Switch, 4-Button
Pictured: Stainless Steel

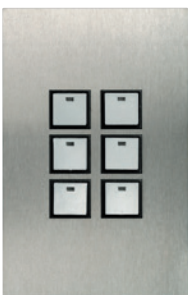

R5066NL
Wall Switch, 6-Button
Pictured: Stainless Steel

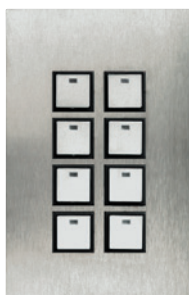

R5068NL
Wall Switch, 8-Button
Pictured: Stainless Steel

AVAILABLE COLOURS

Reflection Series

■ Stainless Steel (R506xyNL)

Note: 'x' denotes number of buttons: i.e. 1, 2, 3, 4, 6 or 8 buttons. 'y' denotes vertical orientation. (Applicable to 2 and 4 button options).

C-Bus Input Units

Wall Switches

C-Bus Standard Series Wall Switches

- May be programmed as dimmers, timers and ON/OFF toggle switches
- 1, 2 or 4 buttons per wall switch
- Each unit features a programmable status indicator
- Units draw 18mA from a C-Bus network
- C-Bus Learn Enabled
- Slimline and Eclipse Series are available with either orange or blue LED indicators

2000 Series



5031NL
Wall Switch, 1-Button,
Orange LED

Pictured: White

Classic C2000 Series



C5031NL
Wall Switch, 1-Button,
Orange LED

Pictured: White

Slimline SC2000 Series



SC5031NL
Wall Switch, 1-Button,
Orange LED

Pictured: White

Eclipse SL2000 Series



SL5031NL
Wall Switch, 1-Button,
Orange LED

Pictured: White

AVAILABLE COLOURS

- White (503xNL-WE)
- Cream (503xNL-CM)
- Black (503xNL-BK)
- Desert Sand (503xNL-DS)
- Soft Grey (503xNL-SG)

- White (C503xNL-WE)
- Cream (C503xNL-CM)
- Black (C503xNL-BK)
- Desert Sand (C503xNL-DS)
- Soft Grey (C503xNL-SG)

- White (SC503xNL-WE)
- Cream (SC503xNL-CM)
- Black (SC503xNL-BK)
- Desert Sand (SC503xNL-DS)
- Soft Grey (SC503xNL-SG)

- White (SL503xNL-WE)
- Cream (SL503xNL-CM)
- Black (SL503xNL-BK)
- Desert Sand (SL503xNL-DS)
- Soft Grey (SL503xNL-SG)

Note: 'x' denotes number of buttons: i.e. 1, 2 or 4 buttons.

C-Bus Input Units

Wall Switches

C-Bus Metal Plate and Multi-Gang Wall Switches

- May be programmed as dimmers, timers and ON/OFF toggle switches
- Each button features a programmable LED status indicator
- Available in Stainless Steel and Brass finishes
- The buttons are available in White or Black
- Wall boxes are supplied when ordering 8-button or higher configurations
- Each 4-button unit array draws 18mA from a C-Bus network
- C-Bus Learn Enabled

'A' Style Deep Curved Plate, Brass



- BA5031NL**
Wall Switch, 1-Button
- BA5032NL**
Wall Switch, 2-Button
(Pictured)
- BA5034NL**
Wall Switch, 4-Button

'B' Style Flat Plate, Brass

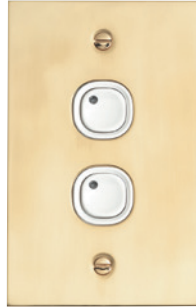

- BB5031NL**
Wall Switch, 1-Button
- BB5032NL**
Wall Switch, 2-Button
(Pictured)
- BB5034NL**
Wall Switch, 4-Button

'B' Style Brass Flat Plate



- 5008B164/3L**
Wall Switch, 8-Button
- 5012B164/4L**
Wall Switch, 12-Button
- 5020B164/7L**
Wall Switch, 20-Button
- 5024B164/8L**
Wall Switch, 24-Button,
Horizontal
(Pictured)

'A' Style Deep Curved Plate, Stainless Steel



- A5031NL**
Wall Switch, 1-Button
- A5032NL**
Wall Switch, 2-Button
(Pictured)
- A5034NL**
Wall Switch, 4-Button

'B' Style Flat Plate, Stainless Steel



- B5031NL**
Wall Switch, 1-Button
- B5032NL**
Wall Switch, 2-Button
(Pictured)
- B5034NL**
Wall Switch, 4-Button

'B' Style Stainless Steel Flat Plate



- 5008S164/3L**
Wall Switch, 8-Button
- 5012S164/4L**
Wall Switch, 12-Button
- 5016S164/6L**
Wall Switch, 16-Button,
Horizontal
- 5016S162/3L**
Wall Switch, 16-Button,
Vertical
- 5020S164/7L**
Wall Switch, 20-Button
- 5024S164/8L**
Wall Switch, 24-Button,
Horizontal (Pictured)

AVAILABLE COLOURS

Buttons

- White (WE)
- Black (BK)

C-Bus Input Units

Wall Switches

C-Bus 30 Mechanism Wall Switches

- Mounts into any Clipsal grid plate with a 30M aperture (ordered separately). See figures 1 and 2.
- Available in master and slave mechanisms
- Master mechanism can accommodate up to 3 slaves
- Master available in IR or non-IR variants
- Programmable as ON/OFF toggle, dimmer, timer, scene control and custom functions
- Selectable blue and orange LED indicator configured through C-Bus Toolkit software
- LED button indicator provides illumination and status feedback
- Night light feature
- Fallback level option to dim indicator at a set time after the last button press
- Programmed via Learn mode or the C-Bus Toolkit software
- Draws 18mA from the C-Bus network
- Labelling option for each button
- Available in White only
- C-Bus Learn Enabled



1.



2.

**C-Bus 30 Mechanism Wall
Switches - Accessories**



5031NMMIRL
30M Wall Switch
Master + IR, White

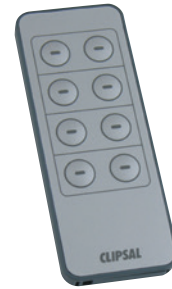

5038TX2
C-Bus 30M 8-Button,
Handheld Infrared
Remote Control, for
C-Bus 30M Switches
(also suits Neo Wall
Switches, C-Bus
Multi-Sensor and
503xNIRL Series
Wall Switches)



5031NMML
30M Wall Switch
Master, White



5031NMS
30M Wall Switch
Slave, White

AVAILABLE COLOURS

White

C-Bus Input Units

General Input Units

C-Bus Single-Zone Thermostat

- Single-zone C-Bus thermostat
- Wall-mounted
- Dimensions 92mm x 127mm x 24mm
- Support for control of HVAC equipment via C-Bus or the internal HVAC relays
- Manually adjustable temperature set point and mode of operation (heating, cooling or ventilation)
- The unit includes fan speed control and a Setback mode
- Easy to use operator interface includes an integral LCD to display the current temperature and mode of operation
- Draws 40mA from a C-Bus network



5070THBR



C-Bus Thermostat, Programmable, Single-Zone with 5 Relays (relays for HVAC plant control only, not accessible via C-Bus)

5070THB

C-Bus Thermostat, Programmable, Single-Zone, (no onboard HVAC plant control relays)

AVAILABLE COLOURS

Saturn Style

-  White (5070THxyPG-WE)
-  Black (5070THxy-BK)
-  Stainless Steel (5070THxy-SS)

Note: 'x' denotes basic (B) or programmable (P).
'y' denotes relays onboard (R).

C-Bus 4-Zone Thermostat with Programmable Time Scheduling

- 4 zones (plus the common zone), programmable C-Bus Thermostat
- Wall-mounted
- Dimensions 105mm x 149mm x 24mm
- Support for control of HVAC equipment via C-Bus or directly using onboard HVAC relays
- Manually adjustable temperature set point, mode of operation (heating, cooling or ventilation) and time schedules
- Onboard 7-day HVAC time scheduling (user programmable), manual fan speed control and Setback mode
- Easy to use interface, comprising an LCD, manual control buttons and a rotating dial with an integral push-button
- Draws 40mA from a C-Bus network





5070THPR
C-Bus Thermostat, Programmable, 4-Zone, with 5 Relays (relays for HVAC plant control only, not accessible via C-Bus)

5070THP
C-Bus Thermostat, Programmable, 4-Zone (no onboard HVAC plant control relays)

AVAILABLE COLOURS

Saturn Style

-  White (5070THxyPG-WE)
-  Black (5070THxy-BK)
-  Stainless Steel (5070THxy-SS)

Note: 'x' denotes basic (B) or programmable (P).
'y' denotes relays onboard (R).

C-Bus Input Units

General Input Units

C-Bus General Input Unit

- 4-channel general analogue/digital input unit, DIN rail mounted
- 8M DIN modules wide
- Dimensions 144mm x 85mm x 65mm
- Used to interface a C-Bus system to third party products, such as light level sensors, current sensors, temperature sensors, CO₂ detectors, differential sensors, pressure sensors, flow rate sensors, moisture probes, etc.
- Designed to either trigger the state of a C-Bus group address as a function of input level or broadcast a message on the C-Bus network, representing the input level
- Maximum of 10 units on a single C-Bus network
- Can be used to measure analogue values (0–1V, 0–5V, 0–10V, 0–20V, 0–20mA, 4–20mA, 500 ohm, 1k ohm, 3k ohm and 10k ohm thermistor inputs)
- Requires a 24V d.c. connection (power pack included)
- Units draw 18mA from a C-Bus network



5504GI
General Input Unit, 4-Channel

C-Bus Bus Coupler

- 5104BCL used to interface up to 4 standard voltage-free mechanical switches, including latching and toggle switches to C-Bus
- 5104BCL supports onboard scenes
- 5102BCLEDL used to interface up to 2 standard voltage free mechanical switches, including latching and toggle switches to C-Bus, incorporates remote LED facility
- Dimensions 55mm x 49mm x 18mm
- The unit is designed to fit into a standard wall box
- Each unit features a programmable status indicator
- The maximum distance between the unit and an external voltage free switch is limited to 1 metre (use L5504AUX if longer distance required)
- Units draw 18mA from a C-Bus network
- C-Bus Learn Enabled

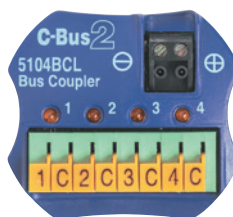

5104BCL
Bus Coupler Input Unit,
4-Channel



5102BCLEDL
Bus Coupler Input Unit,
2-Channel, with Remote LED
Facility

C-Bus DIN Rail-Mounted Auxiliary Input Unit

- 4-channel auxiliary input module, DIN rail-mounted
- 4M DIN modules wide
- Dimensions 72mm x 85mm x 65mm
- Permits voltage-free switches to be connected to C-Bus, such as Clipsal 30 Series Mechanisms, limit switches and weatherproof switches
- Each unit features a programmable status indicator
- The unit may be programmed in the same way as a wall switch, to achieve the same functions such as timer, dimmer or toggle switches
- Draws 18mA from a C-Bus network
- C-Bus Learn Enabled



L5504AUX
Auxiliary Input
Module, 4-Channel

C-Bus Input Units

General Input Units

C-Bus Digital Temperature Sensor Input Unit and Sensors

- 4-channel Digital Temperature Sensor Input Unit
- 1 Digital Temperature Sensor per input channel (empty channels are permitted)
- Digital Temperature Sensors
 - 3 temperature sensor types:
 - o FLAT tip, 4.5mm (W) x 7mm (H) x 20mm (L)
 - o TUBE tip, 6mm (dia.), 30mm (L)
 - o POINT tip, 6mm (dia.), 12mm (L).
- Temperature sensor cable is 2-conductor, insulated and 2m in length
- Temperature sensors are powered by the Input Unit
- Maximum extension length is 25m per temperature sensor
- Temperature sensor tip material – 314 grade stainless steel
- Input Unit contains LED indicators for temperature sensor connection status
- Input Unit detects reverse connection, short or open circuit and failure of connected temperature sensors
- Measurement range from -40°C to 100°C
- Temperature measurement resolution of 0.1°C
- Temperature measurement accuracy:
 - o -40°C to -10°C: $\pm 2^{\circ}\text{C}$
 - o -10°C to 80°C: $\pm 0.5^{\circ}\text{C}$
 - o 80°C to 100°C: $\pm 2^{\circ}\text{C}$.
- Operating temperature range of 0°C to 65°C
- Configurable frequency of temperature broadcast on C-Bus
- Temperature offset feature within programming
- Operates on C-Bus Measurement or C-Bus HVAC applications
- Unit draws 18mA from a C-Bus network



5104DTSI

C-Bus Digital Temperature Sensor Input Unit, 4-Channel (sensors sold separately)



5100DTSF

Temperature Sensor, FLAT Tip



5100DTST

Temperature Sensor, TUBE Tip



5100DTSP

Temperature Sensor, POINT Tip

C-Bus Temperature Sensor

- Used to measure and regulate either heating or cooling in the range 0–50 degrees celsius
- Digital sensor (doesn't require calibration in the field)
- Programmable target temperature and margin on installation
- Programmable set back temperature for when room is unoccupied
- Broadcast of temperature over C-Bus network
- Adjustable temperature broadcast interval
- Temperature offset capabilities
- Provides additional zone sensors for the C-Bus 4-Zone Thermostat
- Units draw 18mA from a C-Bus network



5031RDTSL-WE
C-Bus Temperature
Sensor, 0–50
Degrees Celsius,
2000 Series

C-Bus Surface Mount Light Level Detector

- Used to measure and regulate lighting in the range of 0-1500 lux
- Programmable target light level and margin on installation
- Target light level and margin are adjustable from C-Bus (Surface Mount model only)
- Can be used to achieve bank switching or continuous dimming
- Available in outdoor weatherproof 56 Series Enclosure
- Units draw 15mA (Surface Mount) and 18mA (Weatherproof) from a C-Bus network



5754PE
C-Bus Light Level
Detector, 0–1500
lux, Surface Mount



5031PEWP-GY
C-Bus Light Level
Sensor, 40–1600
lux, Weatherproof,
56 Series

C-Bus Input Units

General Input Units

C-Bus Passive Infrared (PIR) Motion Detector - Outdoor

- C-Bus PIR Motion Detector suitable for outdoor use
- The unit has a field of view of 110° and a detection range which extends 18 metres
- The unit features a light threshold adjustment on the unit
- The time delay is programmable in the range: 1 second to 18 hours
- Features a Sunset Switch program
- Draws 18mA from a C-Bus network



5750WPL-GY
C-Bus Motion Detector, Infrared, IP66, Outdoor

Field of View (At Maximum Sensitivity)

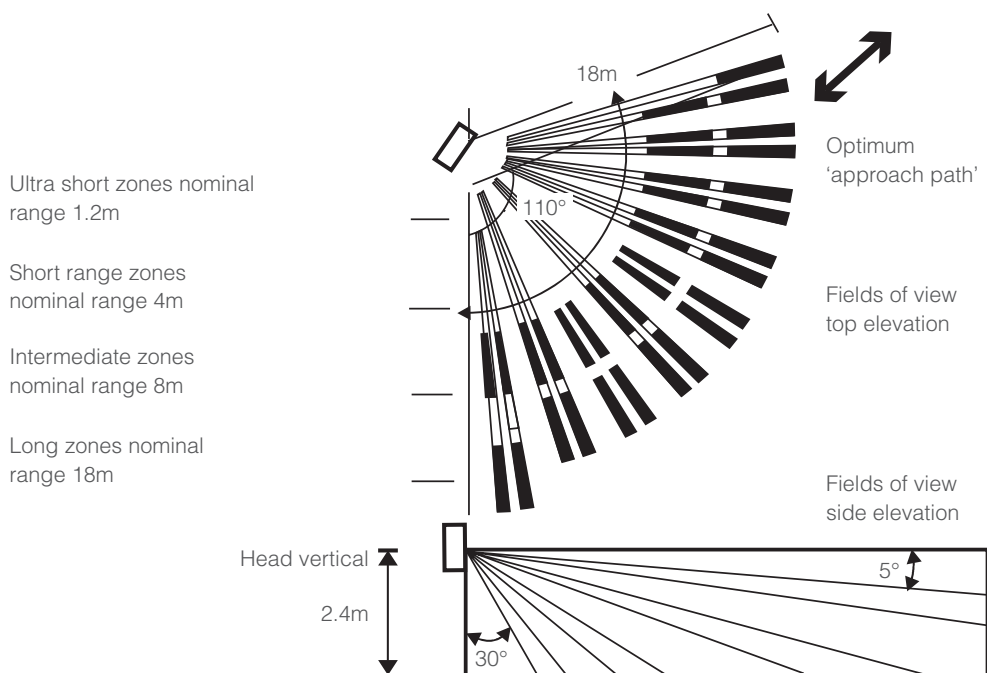

There may be noticeable differences in the range due to differing conditions (background temperature, speed of movement, types of clothing worn, etc.)

C-Bus Passive Infrared (PIR) Motion Detector - Indoor

- C-Bus PIR Motion Detector suitable for indoor use
- The unit has a coverage range of 6m x 6m and a field of view of 90°
- The unit features a light threshold adjustment on the unit
- The time delay is programmable in the range: 1 second to 18 hours
- Features a Sunset Switch program
- Draws 18mA from a C-Bus network



5751L-WE
C-Bus Motion
Detector, Infrared,
Indoor, Corner
Mount

Field of View

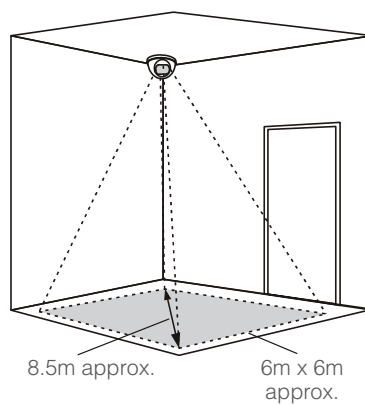
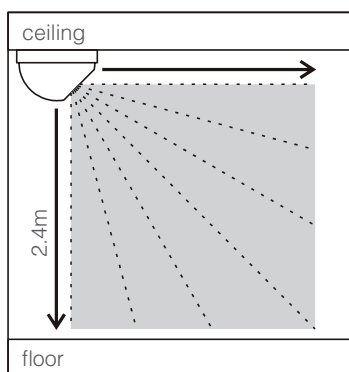

C-Bus Input Units

General Input Units

C-Bus Passive Infrared (PIR) Motion Detector - 360°

- Flush mount, 360°, ceiling mount PIR motion detector
- Suitable for indoor use
- The unit has a coverage range of 6m x 6m and a field of view of 360°
- The unit features a light threshold adjustment on the unit
- The time delay is programmable in the range 1 second to 18 hours
- Features a Sunset Switch program
- Draws 18mA from a C-Bus network



5753L

C-Bus Motion Detector, Infrared, Indoor, Flush Mount, 360°

C-Bus Multi-Sensor

- Flush mount, 360°, ceiling mount multi-sensor
- Combined PIR motion detector, light level sensor and IR receiver
- Capable of controlling up to 8 C-Bus scenes or 8 C-Bus group addresses
- Supports the 'corridor linking' feature for commercial building applications
- Three LEDs indicate a range of actions from movement, to the receiving of IR commands and the device's status
- Light and PIR sensitivity are set via adjustment screws located on the sensor unit
- Dual element detectors minimise false triggering
- An LED status indicator on the unit is used to report the current state of the load controlling device
- Draws 18mA from a C-Bus network
- C-Bus Learn Enabled



5753PEIRL

C-Bus Multi-Sensor, Combined Motion Detector, Light Level Sensor and IR Receiver

Field of View (5753L and 5753PEIRL)

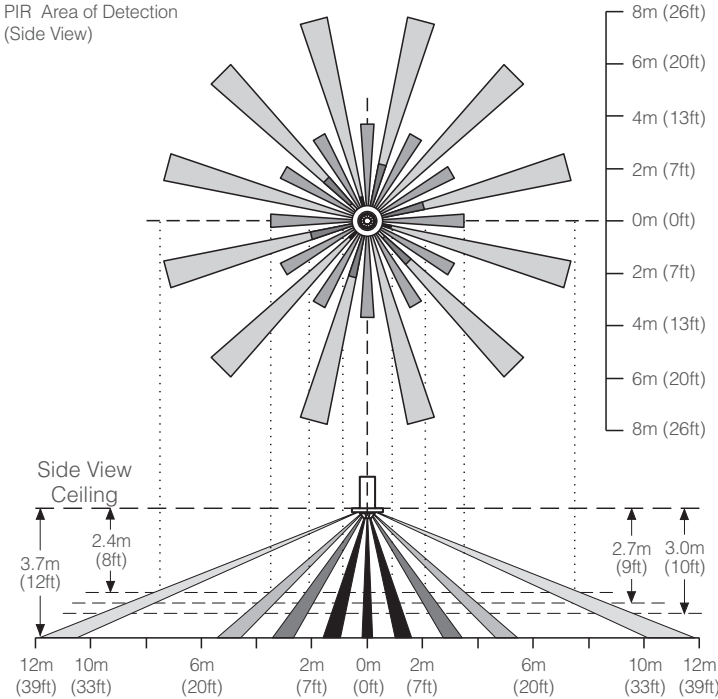

The 5753PEIRL IR Receiver range is 5m circular when using the 5088TX.

The stated field of view is typical for full body movement and is subject to variations caused by the type and quantity of clothing worn, as well as variable background temperature characteristics and speed of movement. Rapid and large temperature changes may be detected, even if they appear to be well beyond the field of view, due to reflections off surfaces that are within the field of view.

C-Bus Input Units

General Input Units

C-Bus Surface Mount Detectors

- Mounting solution suits surface mount applications
- Quickly mounts on solid surfaces such as masonry or wood
- Low-profile surface mount design – extends only 33mm from the mounting surface
- Uses passive infrared (PIR) detection with manually adjustable sensitivity to motion
- Software programmable time delay
- Motion detection coverage typically 7.6m diameter (at 2.7m mounting height)
- C-Bus control of light level target, light level margin, high/low lux levels and high/low thresholds
- Bank switching of lighting levels based upon the light level set point
- Daylight Harvesting to maintain a constant user-configured light level
- Infrared (IR) receiver for control from C-Bus Remote Control devices (5754ODPEIR only)



5754ODPEIR

C-Bus 360° Occupancy and Light Level Detector with IR Receiver, Surface Mount

5754ODPE

C-Bus 360° Occupancy and Light Level Detector, Surface Mount

Field of View (5754ODPEIR and 5754ODPE)

PIR Area of Detection (Top View)

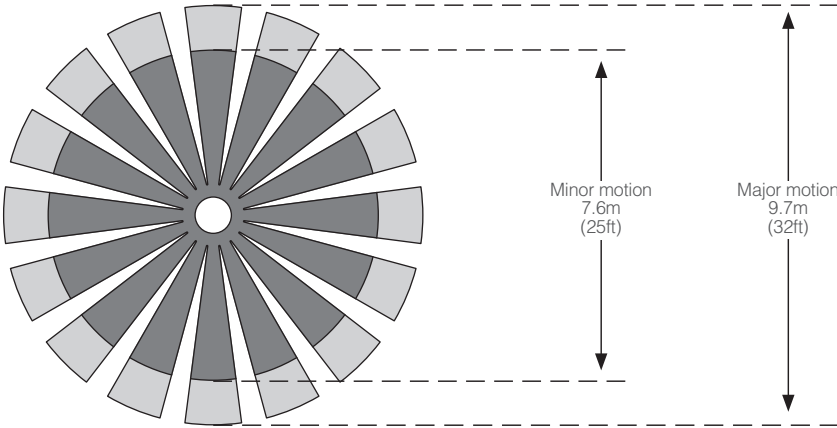

PIR Area of Detection (Side View)

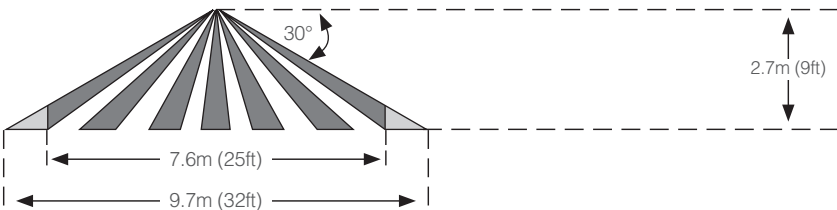

C-Bus Input Units

General Input Units

C-Bus Occupancy Controllers and Detectors

- Perfect for occupancy detection in commercial applications
- Suitable for areas such as meeting rooms, stairwells, open plan office environments, car parks and washrooms
- Available in 1- or 2-zone models
- Wide range of PIR, ultrasonic and PIR/ultrasonic (Dual Technology) wall and ceiling mount detectors, with 110°–360° detection ranges
- Connect to up to three motion detectors per zone
- The C-Bus Occupancy Controller unit provides power to the detectors
- Segregated LV and ELV compartments
- Onboard 16A relay(s)
- Tested and rated to switch multiple mains phases
- Fully self-contained (cable directly to the unit)
- The occupancy controller is pre programmed and works out of the box
- Occupancy controllers function with or without a C-Bus connection
- Quick and easy to install
- Multiple mounting options (keyhole or hanging)
- Highly flexible advanced programming options including corridor linking and multiple join modes for meeting rooms
- Auxiliary inputs for standard Clipsal Switch types (push-button or toggle-type switches)
- Onboard timers (1 minute - 4 hours) and relay fail-safe mode
- Remote override ON/OFF capability
- C-Bus supply voltage: 15–36V d.c. @ 25mA (does not provide power for C-Bus network)
- Detector supply voltage: 24V d.c. 280mA (140mA per zone)
- 2-zone dimmer model provides control outputs for DSI, DALI (broadcast) or 0/10V analogue signals

C-Bus Occupancy Controllers



5752PP/1R
1-Zone C-Bus
Occupancy
Controller with 1
Relay



5752PP/2R
2-Zone C-Bus
Occupancy
Controller with 2
Relays



5752PP/2R/2D
2-Zone C-Bus
Occupancy
Controller with
2 Relays and 2
Dimmer Outputs:
DSI/DALI/0-10 V

Occupancy Detectors



752/CP
Ceiling Mount 360°,
PIR Motion Detector



752/WP
Wall Mount 110°,
PIR Motion Detector



752/CU
Ceiling Mount 360°,
Ultrasonic Motion
Detector



752/CD
Ceiling Mount 360°,
PIR/Ultrasonic
Motion Detector

C-Bus Input Units

General Input Units

C-Bus Infrared (IR) Receivers

- Wall-mounted C-Bus IR Receiver incorporating 4 stations of IR receivers
- Available with or without C-Bus buttons
- May be programmed to achieve functions such as a dimmer, timer or toggle switch
- Units draw 18mA from a C-Bus network
- C-Bus Learn Enabled
- Status indicators

2000 Series



5031NIRL
4-Channel Infrared Receiver Only
Pictured: White



5034NIRL
4-Channel Infrared Receiver with 4 Buttons
Pictured: White

Classic C2000 Series



C5031NIRL
4-Channel Infrared Receiver Only
Pictured: White



C5034NIRL
4-Channel Infrared Receiver with 4 Buttons
Pictured: White

Slimline SC2000 Series



SC5031NIRL
4-Channel Infrared Receiver Only
Pictured: White



SC5034NIRL
4-Channel Infrared Receiver with 4 Buttons
Pictured: White

Eclipse SL2000 Series



SL5031NIRL
4-Channel Infrared Receiver Only
Pictured: White



SL5034NIRL
4-Channel Infrared Receiver with 4 Buttons
Pictured: White

AVAILABLE COLOURS

-  White (503xNIRL-WE)
-  Cream (503xNIRL-CM)
-  Black (503xNIRL-BK)
-  Desert Sand (503xNIRL-DS)

-  White (C503xNIRL-WE)
-  Cream (C503xNIRL-CM)
-  Black (C503xNIRL-BK)
-  Desert Sand (C503xNIRL-DS)

-  White (SC503xNIRL-WE)
-  Cream (SC503xNIRL-CM)
-  Black (SC503xNIRL-BK)
-  Desert Sand (SC503xNIRL-DS)

-  White (SL503xNIRL-WE)
-  Cream (SL503xNIRL-CM)
-  Black (SL503xNIRL-BK)
-  Desert Sand (SL503xNIRL-DS)

Note: 'x' denotes number of buttons:
i.e. 1 (zero button) or 4 buttons.

C-Bus Input Units

Remote Controls

C-Bus Handheld Infrared Transmitters

- Saturn style
- Designed for use with C-Bus 30 Mechanism Wall Switches, C-Bus Neo Wall Switches, C-Bus Detectors (with IR Receiver) and the 503xNIRL Series Wall Switches
- 4- and 8-button units available
- Range of up to 15m (line of sight)
- Features IR bank selection switch with each group of 4 buttons assigned to either bank A/B or bank C/D
- The bank selection is changed by removing the back cover



5084TX
4-Button C-Bus
Infrared Remote
Control with Holder



5088TX
8-Button C-Bus
Infrared Remote
Control with Holder



5080TXC
C-Bus Remote
Control Holder
(Spare)

C-Bus Input Units

Touch Screen Controllers

C-Touch 6.4" Colour Touch Screen Controllers

- Available in Saturn, Neo or Metal Series Surrounds
- 6.4" (diagonal), VGA, 640 x 480 pixels, colour LCD screen
- Displays pages of graphical items, such as buttons, sliders and images that perform C-Bus related functions when pressed
- Includes a real-time clock for automatic scheduling of events based on the time of day, week, month or year
- Controllable via an infrared handheld remote control unit
- Fully customised to suit user requirements via the included Windows™ compatible configuration software
- The software includes a logic engine module that allows the installer to program logic based (if-then-else) control into the touch screen configuration
- Connects directly to a C-Bus network (no external C-Bus PC Interface required)
- Control and monitor devices connected to C-Bus, Ethernet and RS-232 (custom Ethernet and RS-232 support via the included logic programming language)
- Unit programmable via an Ethernet connection
- Client/server plug-in for Windows Media Player
- Animated buttons with more than 256 animation frames supported
- Fully customisable graphics including bar graphs, sliders, percentage indicators, images, gauges and clocks with any border and background style
- Supports web page embedding
- Supports IP camera inputs
- Supports project theme templates
- Audio WAV file support
- Scene control
- Event scheduling support
- Irrigation control
- Password access control
- Dimensions: 246mm x 173mm x 72.5mm (excluding fascia)
- Cut-out size 208mm x 162mm

Saturn Series



5080CTC3-PW

Colour Touch Screen Controller, 6.4" Colour, Pure White Glass Fascia (less wall box, less power supply)

Pictured: Saturn Pure White

AVAILABLE COLOURS

- Saturn Pure White (5080CTC3-PW)
- Saturn White (5080CTC3-GF)
- Saturn Cream (5080CTC3-3)
- Saturn Black (5080CTC3-6)
- Saturn Mid-Brown (5080CTC3-7)

Neo Series



5050CTC3-GB

Colour Touch Screen Controller, 6.4" Colour, Neo Battleship Grey Fascia (less wall box, less power supply)

Pictured: Neo Battleship Grey/Brushed Aluminium

- Neo Battleship Grey/Brushed Aluminium (5050CTC3-GB)
- Neo White (5050CTC3-WE)
- Neo Black (5050CTC3-BK)
- Neo White/Brushed Aluminium (5050CTC3-28)

Metal Series



BS5000CTC3

'B' Style Metal Fascia, Colour Touch Screen Controller, 6.4" Colour, Stainless Steel Fascia (less wall box, less power supply)

Pictured: Stainless Steel

- Stainless Steel (BS5000CTC3)
- Horizon Black (HB5000CTC3)

C-Bus Input Units

Touch Screen Controllers

C-Touch Spectrum Colour Touch Screen Controllers

- Wall mount or desktop, touch-sensitive colour LCD touch screen controllers
- Displays 'pages' of graphical items, such as buttons, sliders and images, that can perform C-Bus-related functions when pressed
- 320 x 240 pixel 65k colour LCD
- Adjustable LED backlighting with ambient light compensation
- Powered from C-Bus
- Proximity sensing for wake-up and control functions
- Anti-fingerprint screen
- Available with or without C-Bus Logic Engine features
- Programmed via a standard USB port (easily accessible)
- USB port can be used as a PC interface to a C-Bus system
- Separate RS-232 port is included for third party device integration (C-Bus Logic Engine model only)
- Programmed using drag and drop programming software (PICED)
- Real-time clock included for automatic scheduling of events
- Allows control from infrared handheld remote control
- Wide range of fascia colours and styles available (Saturn, Neo, Metal and Plastic versions)
- Dimensions 195mm x 136mm x 41.7mm (Saturn model)
- Units draw 75mA and are powered from C-Bus (separate power supply not required)
- Wall box ordered separately
- Wall cut-out size: 173.5mm x 114.5mm

Saturn Series - Wall Mount



C-5080CT2 and C-5080CTL2
Colour Touch Screen Controller, Saturn Glass Fascia, available with and without C-Bus Logic Engine

Pictured: Saturn White

Metal Series - Wall Mount

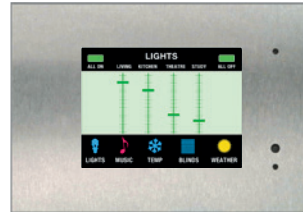

C-xx5000CT2 and C-xx5000CTL2
Colour Touch Screen Controller, Metal Fascia, available with and without C-Bus Logic Engine

Pictured: Stainless Steel

Neo Series - Wall Mount



C-5050CT2 and C-5050CTL2
Colour Touch Screen Controller, Neo Fascia, available with and without C-Bus Logic Engine

Pictured: Neo Battleship Grey/Brushed Aluminium

Plastic Series - Wall Mount

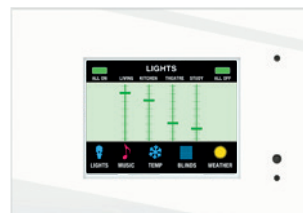

C-SC5000CT2 and C-SC5000CTL2
Colour Touch Screen Controller, Plastic Fascia, available with and without C-Bus Logic Engine

Pictured: White

Desktop Series



C-5000CTD2 and C-5000CTL2
Colour Touch Screen Controller, Desktop, available with and without C-Bus Logic Engine

Pictured: White

AVAILABLE COLOURS



Saturn Series

-  Saturn White (GF)
-  Saturn Pure White (PW)
-  Saturn Cream (3)
-  Saturn Black (6)
-  Saturn Mid-Brown (7)



Neo Series

-  Neo White (WE)
-  Neo White/Brushed Aluminium (28)
-  Neo Battleship Grey (GB)
-  Neo Black (BK)

Plastic Series

-  White (WE)
-  Cream (CM)
-  Black (BK)

Metal Series

-  Stainless Steel (BS)
-  Brass (BB)
-  Horizon Black (HB)

Desktop Series

-  White (WE)
-  Grey (GY)
-  Black (BK)

C-Bus Input Units

Touch Screen Controllers

B&W MKII Touch Screen Controllers

- Wall mount or desktop, touch-sensitive black and white LCD touch screen controllers
- Displays 'pages' of graphical items, such as buttons, sliders and images, that can perform C-Bus related functions when pressed
- LCD resolution of QVGA (320 pixels x 240 pixels)
- Adjustable LCD screen backlighting with ambient light compensation
- LCD uses white on black technology to enhance clarity
- Available with or without C-Bus Logic Engine features.
- Programmed via a standard USB port (easily accessible)
- USB port can be used as a PC interface to a C-Bus System
- Separate RS-232 port is included for third party device integration (C-Bus Logic Engine model only)
- Compatible with version 4 of Clipsal's Windows based drag and drop programming software (PICED)
- Real-time clock included for automatic scheduling of events
- Allows control from infrared handheld remote control
- Wide range of fascia colours and styles available (Saturn, Neo, Metal and Plastic versions)
- Dimensions 195mm x 136mm x 41.7mm (Saturn model)
- Units draw 65mA and are powered from C-Bus (separate power supply not required)
- Wall box ordered separately
- Wall cut-out size: 173.5mm x 114.5mm

Saturn Series - Wall Mount



5080CT2 and 5080CTL2
B&W MKII Touch Screen Controller, Saturn Glass Fascia, available with and without C-Bus Logic Engine

Pictured: Saturn White

Metal Series - Wall Mount

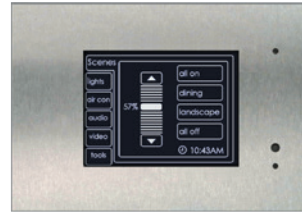

xx5000CT2 and xx5000CTL2
B&W MKII Touch Screen Controller, Metal Fascia, available with and without C-Bus Logic Engine

Pictured: Stainless Steel

Neo Series - Wall Mount



5050CT2 and 5050CTL2
B&W MKII Touch Screen Controller, Neo Fascia, available with and without C-Bus Logic Engine

Pictured: Neo Battleship Grey/
Brushed Aluminium

Plastic Series - Wall Mount



SC5000CT2 and SC5000CTL2
B&W MKII Touch Screen Controller Plastic Fascia, available with and without C-Bus Logic Engine

Pictured: Black

Desktop Series



5000CTD2 and 5000CTDL2
B&W MKII Touch Screen Controller, Desktop, available with and without C-Bus Logic Engine

Pictured: Black

AVAILABLE COLOURS



Saturn Series

-  Saturn White (GF)
-  Saturn Pure White (PW)
-  Saturn Cream (3)
-  Saturn Black (6)
-  Saturn Mid-Brown (7)



Neo Series

-  Neo White (WE)
-  Neo White/Brushed Aluminium (28)
-  Neo Battleship Grey (GB)
-  Neo Black (BK)

Plastic Series

-  White (WE)
-  Cream (CM)
-  Black (BK)

Metal Series

-  Stainless Steel (BS)
-  Brass (BB)
-  Horizon Black (HB)

Desktop Series

-  White (WE)
-  Grey (GY)
-  Black (BK)

C-Bus Input Units

Touch Screen Controllers

C-Touch 6.4" Colour Touch Screen Controller Accessories

- Mounting hardware and accessories to suit 6.4" Colour Touch Screen Controllers
- Wall box external dimensions: 224mm x 167mm x 68mm
- Cut-out size for plasterboard bracket: 208mm x 162mm



5000CTCWB
Wall Box for 6.4" Colour Touch Screen Controller

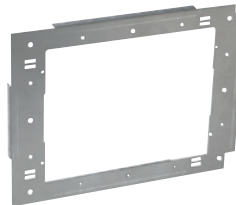

5000CTCNA
Nail Bracket for 6.4" Colour Touch Screen Controller

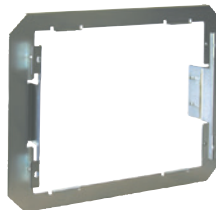

5000CTCRM
Gyproc™ Bracket for 6.4" Colour Touch Screen Controller



5100P24/2700AU
Power Supply to suit C-Bus 6.4" Colour Touch Screen Controller, V3, 24V d.c., 2.7A

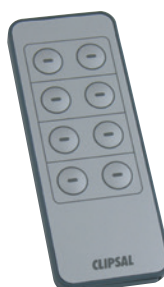

5035TX2
Remote Control to suit C-Bus Touch Screen Controller (Spare)

C-Touch Spectrum Colour and B&W MKII Touch Screen Controller Accessories

- Mounting hardware and accessories to suit C-Touch Spectrum Colour and B&W MKII Touch Screen Controllers
- Wall box external dimensions: 179.5mm x 122.5mm x 55mm



5000CT2WB

Wall Box for C-Touch Spectrum Colour and B&W MKII Touch Screen Controllers



5000CT2RS232

RS232 Lead for Integrating with Third Party Devices (Logic Engine Model Only), suits C-Touch Spectrum Colour and B&W MKII Touch Screen Controllers

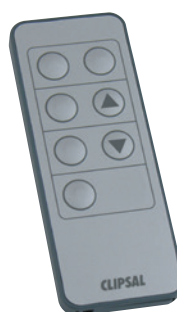

5035TX2

Remote Control to suit C-Bus Touch Screen Controller (Spare)

C-Bus Output Units

Dimmer Units

High Powered Dimmers - Architectural Series with Onboard RCDs

- Modular design with individual dimmer channel cards
- Soft start load turn-on protects lamp filaments
- Voltage compensation to minimise load brightness variation if the a.c. supply voltage drifts
- Filtering reduces supply voltage signalling effects
- Linear output load power following input control
- Universal dimming technology auto-detects load type
- Cards rated at full load current (no derating)
- C-Bus network burden and system clock generator
- After mains fail; dimmers return to previous or preset values
- Local C-Bus override switches on front panel
- Channel status indicators on front control panel
- Onboard MCB protection
- Mounting brackets included for ease of installation
- Generous load and mains supply terminals
- Emergency lighting output for each channel
- Manual dimmer bypass switch on all channels
- Fan-free operation, reduces maintenance requirements
- Suitable for single or 3-phase track lighting applications with optional 3-phase MCBs
- Support for 128 onboard lighting scenes
- Full integration with DMX512
- Selectable predefined dimming curves
- 3 prioritised auxiliary inputs
- Standby generator input
- Cross fading scene functions
- Optional ballast control card - providing relay, DSI, DALI (broadcast) or 0–10V d.c. control
- Complies with Australian (AS/NZS CISPR 15:2002) and International Standards for Light Dimmers
- Meets the requirements of AS/NZS 3000:2007 RCD Protection of Lighting Circuits
- Dimmer models may be available without onboard RCDs, please contact your Clipsal C-Bus specialist for further information

12-Channel

6-Channel

3-Channel

Catalogue No.	Dimensions (mm) H x W x D	Catalogue No.	Dimensions (mm) H x W x D	Catalogue No.	Dimensions (mm) H x W x D
L5112D10UAR6	713 x 455 x 164	L5106D20UAR6	713 x 455 x 164	L5103D20UAR1	451 x 455 x 164
L5112D5UAR6	713 x 412 x 164	L5106D16UAR6	713 x 455 x 164	L5103D16UAR1	451 x 455 x 164
		L5106D10UAR3	451 x 455 x 164	L5103D10UAR1	289 x 455 x 164
		L5106D5UAR3	451 x 412 x 164	L5103D5UAR1	289 x 412 x 164

12-Channel RCD



L5112D10UAR6
12-Channel C-Bus Architectural Dimmer, Universal - 10A Per Channel (6 RCDs Onboard)

6-Channel RCD

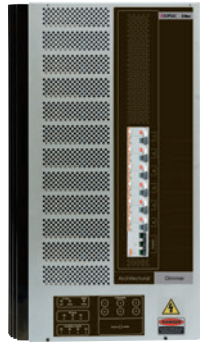

L5106D20UAR6
6-Channel C-Bus Architectural Dimmer, Universal - 20A Per Channel (6 RCDs Onboard)

3-Channel RCD



L5103D20UAR1
3-Channel C-Bus Architectural Dimmer, Universal - 20A Per Channel (1 RCD Onboard)



L5112D5UAR6
12-Channel C-Bus Architectural Dimmer, Universal - 5A Per Channel (6 RCDs Onboard)

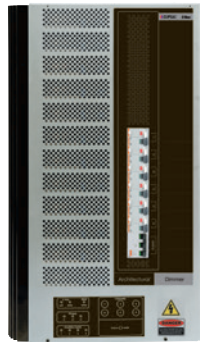

L5106D16UAR6
6-Channel C-Bus Architectural Dimmer, Universal - 16A Per Channel (6 RCDs onboard)



L5103D16UAR1
3-Channel C-Bus Architectural Dimmer, Universal - 16A Per Channel (1 RCD Onboard)



L5106D10UAR3
6-Channel C-Bus Architectural Dimmer, Universal - 10A Per Channel (3 RCDs Onboard)



L5103D10UAR1
3-Channel C-Bus Architectural Dimmer, Universal - 10A Per Channel (1 RCD Onboard)



L5106D5UAR3
6-Channel C-Bus Architectural Dimmer, Universal - 5A Per Channel (3 RCDs Onboard)



L5103D5UAR1
3-Channel C-Bus Architectural Dimmer, Universal - 5A Per Channel (1 RCD Onboard)

C-Bus Output Units

Dimmer Units

High Powered Dimmers - Professional Series with Onboard RCDs

- Modular design with individual dimmer channel cards
- Leading edge dimming technology
- Soft start load turn-on protects lamp filaments
- Voltage compensation to minimise load brightness variation if the a.c. supply voltage drifts
- Filtering reduces supply voltage signalling effects
- Linear output load power following input control
- Cards rated at full load current (no derating)
- C-Bus network burden and system clock generator
- After mains fail, dimmers return to previous or preset values
- Local C-Bus override switches on front panel
- Channel status indicators on front control panel
- Onboard MCB protection
- Mounting brackets included for ease of installation
- Generous load and mains supply terminals
- Emergency lighting output for each channel
- Manual dimmer bypass switch on all channels
- Fan-free operation, reduces maintenance requirements
- Suitable for single or 3-phase track lighting applications with optional 3-phase MCBs
- Optional ballast control card - providing relay, DSI, DALI (broadcast) or 0-10V d.c. control
- Complies with Australian (AS/NZS CISPR 15:2002) and International Standards for light dimmers
- Meets the requirements of AS/NZS 3000:2007 RCD Protection of Lighting Circuits
- Dimmer models may be available without onboard RCDs, please contact your Clipsal C-Bus specialist for further information

12-Channel

6-Channel

3-Channel

Catalogue No.	Dimensions (mm) H x W x D	Catalogue No.	Dimensions (mm) H x W x D	Catalogue No.	Dimensions (mm) H x W x D
L5112D20LPR12	713 x 455 x 164	L5106D20LPR6	451 x 455 x 164	L5103D20LPR1	289 x 455 x 164
L5112D16LPR12	713 x 455 x 164	L5106D10LPR6	451 x 412 x 164	L5103D10LPR1	289 x 412 x 164
L5112D10LPR12	713 x 412 x 164	L5106D5LPR6	451 x 405 x 115	L5103D5LPR1	289 x 405 x 115
L5112D5LPR12	713 x 405 x 115	L5106D10LPR3	451 x 412 x 164		
L5112D10LPR6	713 x 412 x 164	L5106D5LPR3	451 x 405 x 115		
L5112D5LPR6	713 x 405 x 115				

12-Channel RCD

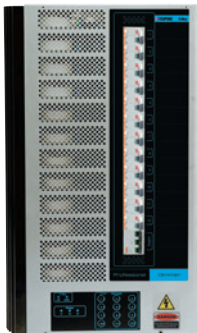

L5112D20LPR12
12-Channel C-Bus Professional Dimmer, LE - 20A Per Channel (12 RCDs Onboard)

L5112D16LPR12
12 Channel C-Bus Professional Dimmer, LE - 16A Per Channel (12 RCDs Onboard)

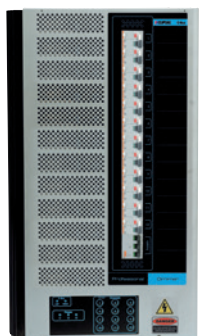

L5112D10LPR12
12-Channel C-Bus Professional Dimmer, LE - 10A Per Channel (12 RCDs Onboard)

L5112D5LPR12
12-Channel C-Bus Professional Dimmer, LE - 5A Per Channel (12 RCDs Onboard)

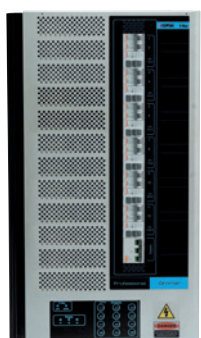

L5112D10LPR6
12-Channel C-Bus Professional Dimmer, LE - 10A Per Channel (6 RCDs Onboard)

L5112D5LPR6
12-Channel C-Bus Professional Dimmer, LE - 5A Per Channel (6 RCDs Onboard)

6-Channel RCD



L5106D20LPR6
6-Channel C-Bus Professional Dimmer, LE - 20A Per Channel (6 RCDs Onboard)



L5106D10LPR6
6-Channel C-Bus Professional Dimmer, LE - 10A Per Channel (6 RCDs Onboard)

L5106D5LPR6
6-Channel C-Bus Professional Dimmer, LE - 5A Per Channel (6 RCDs Onboard)



L5106D10LPR3
6-Channel C-Bus Professional Dimmer, LE - 10A Per Channel (3 RCDs Onboard)

L5106D5LPR3
6-Channel C-Bus Professional Dimmer, LE - 5A Per Channel (3 RCDs Onboard)

3-Channel RCD



L5103D20LPR1
3-Channel C-Bus Professional Dimmer, LE - 20A Per Channel (1 RCD Onboard)



L5103D10LPR1
3-Channel C-Bus Professional Dimmer, LE - 10A Per Channel (1 RCD Onboard)



L5103D5LPR1
3-Channel C-Bus Professional Dimmer, LE - 5A Per Channel (1 RCD Onboard)

C-Bus Output Units

Dimmer Units

High Powered Dimmers - Architectural and Professional Series - Chassis Only

- A selection of C-Bus Architectural Dimmers are available without channel cards including:
 - 6-channel 20A per channel (non-RCD)
 - 12-channel 10A per channel (non-RCD)
 - 6-channel 10A per channel (non-RCD)
 - 6-channel 20A per channel, supplied with 6 RCDs
 - 12-channel 10A per channel, supplied with 12 RCDs
 - 6-channel 10A per channel, supplied with 6 RCDs
- A selection of C-Bus Professional Dimmers are available without channel cards including:
 - 12-channel 20A per channel (non-RCD)
 - 6-channel 20A per channel (non-RCD)
 - 12-channel 10A per channel (non-RCD)
 - 6-channel 10A per channel (non-RCD)
 - 12-channel 20A per channel, supplied with 12 RCDs
 - 6-channel 20A per channel, supplied with 6 RCDs
 - 12-channel 10A per channel, supplied with 12 RCDs
 - 6-channel 10A per channel, supplied with 6 RCDs



L5106D20UAR6C

6 Channel C-Bus Architectural Dimmer, Chassis Only, 20A per channel, 6 RCDs onboard

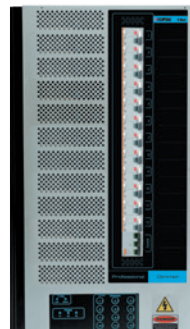

L5112D20LPR12C

12 Channel C-Bus Professional Dimmer, Chassis Only, 20A per channel, 12 RCDs onboard

High Powered Dimmers - Architectural and Professional Series - Channel Cards

- A range of dimmer channel cards are available including:
 - Ballast control / relay output (DSI / DALI / 0 – 10V d.c. or relay output)
 - 20A universal dimming
 - 16A universal dimming
 - 10A universal dimming
 - 5A universal dimming
 - 20A leading edge dimming
 - 16A leading edge dimming
 - 10A leading edge dimming
 - 10A trailing edge dimming
 - 5A leading edge dimming
 - 3A leading edge dimming

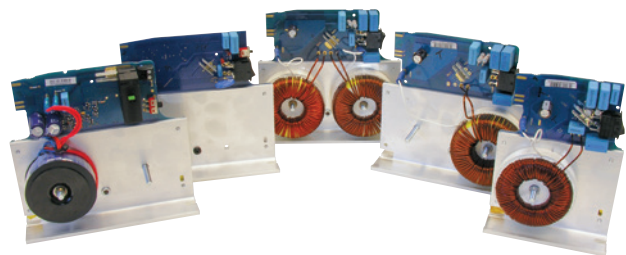

Dimmer Channel Cards

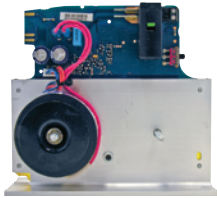

L51CM-SB
Ballast Control Card for Relay,
DSI, DALI (broadcast) or 0–10V
d.c. Control

Accessories



5150DMX
DMX Connector Kit to suit C-Bus
Architectural Dimmers. 3-Way
Phoenix Connector to 2-Panel
Mount XLR Female Connectors

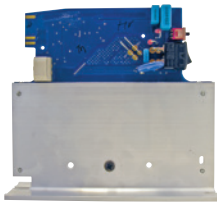

L51CM-SU10
10A Universal Dimming
Channel Card

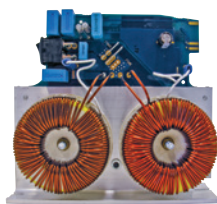

L51CM-SLE20
20A Leading Edge Dimming
Channel Card

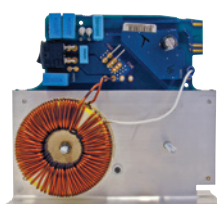

L51CM-SLE10
10A Leading Edge Dimming
Channel Card

C-Bus Output Units

Dimmer Units

DIN Rail-Mounted 4-Channel Universal Dimmer

- 4-channel universal dimmer, DIN rail-mounted
- 12M DIN modules wide
- Dimensions 215mm x 85mm x 65mm
- Features 4 channels of 2.5A rating
- Suitable for use with leading edge or trailing edge compatible low voltage transformers
- Suitable for low voltage electronic transformers, incandescent lamps and low voltage lamps with iron core transformers
- Features automatic load sensing
- Features a software selectable network burden and C-Bus system clock
- A maximum of 10 units may be connected to a C-Bus network
- Features an inbuilt 200mA C-Bus power supply
- C-Bus Learn Enabled



L5504D2U

4-Channel C-Bus Universal Dimmer 250V a.c, 2.5A Per Channel, Inbuilt 200mA C-Bus Power Supply

DIN Rail-Mounted 4-Channel Universal Dimmer - without C-Bus Power Supply

- 4-channel universal dimmer, DIN rail-mounted
- 12M DIN modules wide
- Dimensions 215mm x 85mm x 65mm
- Features 4 channels of 2.5A rating
- Suitable for use with leading edge or trailing edge compatible low voltage transformers
- Suitable for low voltage electronic transformers, incandescent lamps and low voltage lamps with iron core transformers
- Features automatic load sensing
- Features a software selectable network burden and C-Bus system clock
- A maximum of 100 units may be connected to a C-Bus network
- Does not source current to the network
- Draws 18mA from C-Bus when mains is not connected
- C-Bus Learn Enabled



L5504D2UP

4-Channel C-Bus Universal Dimmer 250V a.c, 2.5A Per Channel, No Inbuilt C-Bus Power Supply

DIN Rail-Mounted 8-Channel LE Dimmer

- 8-channel dimmer, DIN rail-mounted
- 12M DIN modules wide
- Dimensions 215mm x 85mm x 65mm
- Leading edge dimming technology
- Features 8 channels of 1A output, suitable for incandescent and low voltage lighting
- Features a software selectable network burden and C-Bus system clock
- A maximum of 10 units may be connected to any C-Bus network
- Features an inbuilt 200mA C-Bus power supply
- C-Bus Learn Enabled



L5508D1A
8-Channel Dimmer 250V a.c.,
1A Per Channel, Inbuilt 200mA
C-Bus Power Supply

DIN Rail-Mounted 8-Channel LE Dimmer - without C-Bus Power Supply

- 8-channel dimmer, DIN rail-mounted
- 12M DIN modules wide
- Dimensions 215mm x 85mm x 65mm
- Leading edge dimming technology
- Features 8 channels of 1A output, suitable for incandescent and low voltage lighting
- Features a software selectable network burden and C-Bus system clock
- A maximum of 100 units may be connected to any C-Bus network
- Does not source current to the network
- Draws 18mA from the C-Bus when mains is not connected
- C-Bus Learn Enabled



L5508D1AP
8-Channel Dimmer 250V a.c.,
1A Per Channel, No Inbuilt
C-Bus Power Supply

C-Bus Output Units

Dimmer Units

Dimmer CFL and Mains LED Bypass Module

- Adapts dimming behaviour of phase cut dimmer output
- Used for direct control of various extra low power electronic load types (such as CFLs and mains powered LEDs)
- Improved dimming performance
- Inbuilt relay eliminates off state current from phase cut dimmer output
- Available in 2M wide DIN rail or inline enclosure



55010SRBD
CFL and Mains LED Bypass
Module, DIN Rail Mount



50010SRBD
CFL and Mains LED Bypass
Module, Inline

LED Load Driver Module

- Adapts dimming behaviour of phase cut dimmer output
- Used for direct control of various extra low voltage LED loads
- 1-channel LED driver
- Constant current 36V, 700mA
- Available in 2M wide DIN rail or inline enclosure



5501LD
Constant Current LED driver, 1
Channel, 36V 700mA, DIN Rail
Mount



5001LD
Constant Current LED Driver, 1
Channel, 36V 700mA, Inline

C-Bus Output Units

Dimmer Units

DIN Rail-Mounted 4-Channel LE Dimmer

- 4-channel dimmer, DIN rail-mounted
- 12M DIN modules wide
- Dimensions 215mm x 85mm x 65mm
- Leading edge dimming technology
- Features 4-channels of 2A output, suitable for incandescent and low voltage lighting
- Features a software selectable network burden and C-Bus system clock
- A maximum of 10 units may be connected to any C-Bus network
- Features a 200mA C-Bus power supply
- C-Bus Learn Enabled



L5504D2A

4-Channel Dimmer 250V a.c,
2A Per Channel, Inbuilt 200mA
C-Bus Power Supply

DIN Rail-Mounted 4-Channel LE Dimmer - without C-Bus Power Supply

- 4-channel dimmer, DIN rail-mounted
- 12M DIN modules wide
- Dimensions 215mm x 85mm x 65mm
- Leading edge dimming technology
- Features 4 channels of 2A output, suitable for incandescent and low voltage lighting
- Features a software selectable network burden and C-Bus system clock
- A maximum of 100 units may be connected to any C-Bus network
- Does not source current to the network
- Draws 18mA from the C-Bus when mains is not connected
- C-Bus Learn Enabled



L5504D2AP

4-Channel Dimmer 250V a.c,
2A Per Channel, No Inbuilt
C-Bus Power Supply

DIN Rail-Mounted 8-Channel DSI Gateway

- 8-channel dimmer for DSI ballasts, DIN rail-mounted
- 12M DIN modules wide
- Dimensions 215mm x 85mm x 65mm
- Provides C-Bus control of electronic DSI digital ballasts
- The module controls up to 100 DSI ballasts per channel
- Up to 10 units may be connected to any C-Bus network
- Used in conjunction with electronic DSI ballasts
- The dimmer features a 200mA C-Bus power supply
- C-Bus Learn Enabled



L5508DSI
8-Channel Dimmer for DSI
Electronic Ballasts 250V a.c.,
Inbuilt 200mA C-Bus Power
Supply

DIN Rail-Mounted 8-Channel DSI Gateway - without C-Bus Power Supply

- 8-channel dimmer for DSI ballasts, DIN rail-mounted
- 12M DIN modules wide
- Dimensions 215mm x 85mm x 65mm
- Provides C-Bus control of electronic DSI digital ballasts
- The module controls up to 100 DSI ballasts per channel
- Up to 100 units may be connected to any C-Bus network
- Used in conjunction with electronic DSI ballasts
- Draws 18mA from the C-Bus network when mains is not connected
- C-Bus Learn Enabled



L5508DSIP
8-Channel Dimmer for DSI
Electronic Ballasts 250V a.c.,
No Inbuilt C-Bus Power Supply

C-Bus Output Units

Relay Units

DIN Rail-Mounted 12-Channel 10A Relay

- 12-channel relay module, DIN rail-mounted
- 12M DIN modules wide
- Dimensions 215mm x 85mm x 65mm
- Featuring 12 channels of voltage-free relay switching
- Rated at 10A incandescent or 10A fluorescent load per channel
- Incorporates a software selectable network burden and C-Bus system clock
- A maximum of 10 units may be connected to any C-Bus network
- Incorporates an inbuilt 200mA C-Bus power supply
- C-Bus Learn Enabled



L5512RVF

12-Channel Relay 250V a.c.,
10A Load Per Channel, Inbuilt
200mA C-Bus Power Supply

DIN Rail-Mounted 12-Channel 10A Relay - without C-Bus Power Supply

- 12-channel relay module, DIN rail-mounted
- 12M DIN modules wide
- Dimensions 215mm x 85mm x 65mm
- Featuring 12 channels of voltage-free relay switching
- Rated at 10A incandescent or 10A fluorescent load per channel
- Incorporates a software selectable network burden and C-Bus system clock
- A maximum of 100 units may be connected to any C-Bus network
- Draws 18mA from C-Bus network when mains is not connected
- C-Bus Learn Enabled



L5512RVFP

12-Channel Relay 250V a.c.,
10A Load Per Channel, No
Inbuilt C-Bus Power Supply

DIN Rail-Mounted 8-Channel 10A Relay

- 8-channel relay module, DIN rail-mounted
- 12M DIN modules wide
- Dimensions 215mm x 85mm x 65mm
- Featuring 8 channels of voltage-free relay switching
- Rated at 10A incandescent or 10A fluorescent load per channel
- Incorporates a software selectable network burden and C-Bus system clock
- A maximum of 10 units may be connected to any C-Bus network
- Incorporates an inbuilt 200mA C-Bus power supply
- C-Bus Learn Enabled

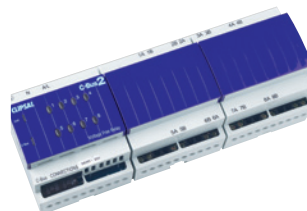

L5508RVF
8-Channel Relay 250V a.c,
10A Load Per Channel, Inbuilt
200mA C-Bus Power Supply

DIN Rail-Mounted 8-Channel 10A Relay - without C-Bus Power Supply

- 8-channel relay module, DIN rail-mounted
- 12M DIN modules wide
- Dimensions 215mm x 85mm x 65mm
- Featuring 8 channels of voltage-free relay switching
- Rated at 10A incandescent or 10A fluorescent load per channel
- Incorporates a software selectable network burden and C-Bus system clock
- A maximum of 100 units may be connected to any C-Bus network
- Draws 18mA from C-Bus network when mains is not connected
- C-Bus Learn Enabled

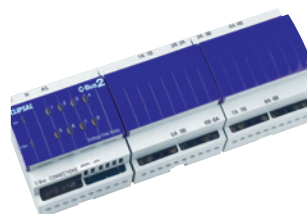

L5508RVFP
8-Channel Relay 250V a.c, 10A
Load Per Channel, No Inbuilt
C-Bus Power Supply

C-Bus Output Units

Relay Units

DIN Rail-Mounted 4-Channel 10A Relay

- 4-channel relay module, DIN rail-mounted
- 8M DIN modules wide
- Dimensions 144mm x 85mm x 65mm
- Featuring 4 channels of voltage-free relay switching
- Rated at 10A incandescent or 10A fluorescent load per channel
- Incorporates a software selectable network burden and C-Bus system clock
- A maximum of 10 units may be connected to any C-Bus network
- Incorporates an inbuilt 200mA C-Bus power supply
- C-Bus Learn Enabled



L5504RVF

4 Channel Relay, 250V a.c., 10A Load Per Channel, Inbuilt 200mA C-Bus Power Supply

DIN Rail-Mounted 4-Channel 10A Relay - without C-Bus Power Supply

- 4-channel relay module, DIN rail-mounted
- 8M DIN modules wide
- Dimensions 144mm x 85mm x 65mm
- Featuring 4 channels of voltage-free relay switching
- Rated at 10A incandescent or 10A fluorescent load per channel
- Incorporates a software selectable network burden and C-Bus system clock
- A maximum of 100 units may be connected to any C-Bus network
- Draws 18mA from C-Bus network when mains is not connected
- C-Bus Learn Enabled



L5504RVFP

4 Channel Relay 250V a.c., 10A Load Per Channel, No Inbuilt C-Bus Power Supply

DIN Rail-Mounted 4-Channel 20A Relay

- 4-channel 20A relay module, DIN rail-mounted
- 12M DIN modules wide
- Dimensions 215mm x 85mm x 65mm
- 4 channels of voltage-free relay switching
- Rated at 20A incandescent, 20A HID or 20A fluorescent load per channel
- Relays feature magnetic latching
- Built-in mechanical level for manual changeover of relay state
- Incorporates a software selectable network burden and C-Bus system clock
- A maximum of 10 units may be connected to any C-Bus network
- Incorporates an inbuilt 200mA C-Bus power supply
- C-Bus Learn Enabled



L5504RVF20

4 Channel Relay, 250V a.c,
20A Load Per Channel, Inbuilt
200mA C-Bus Power Supply

DIN Rail-Mounted 4-Channel 20A Relay - without C-Bus Power Supply

- 4-channel 20A relay module, DIN rail-mounted
- 12M DIN modules wide
- Dimensions 215mm x 85mm x 65mm
- 4 channels of voltage-free relay switching
- Rated at 20A incandescent, 20A HID or 20A fluorescent load per channel
- Relays feature magnetic latching
- Built-in mechanical level for manual changeover of relay state
- Incorporates a software selectable network burden and C-Bus system clock
- A maximum of 100 units may be connected to any C-Bus network
- Draws 18mA from the C-Bus when mains is not connected
- C-Bus Learn Enabled



L5504RVF20P

4-Channel Relay, 250V a.c, 20A
Load Per Channel, No Inbuilt
C-Bus Power Supply

C-Bus Output Units

Relay Units

DIN Rail-Mounted 4-Channel Changeover Relay

- 4-channel changeover relay with interlock features, DIN rail-mounted
- 8M DIN modules wide
- Dimensions 144mm x 85mm x 65mm
- Used for control of air conditioning systems (ON/OFF, low, medium and high) and shutter or blind control (UP/DOWN)
- The unit can be simply wired to achieve electrical interlocking, for use where outputs are all mutually exclusive
- Rated at 10A resistive, 5A incandescent/inductive, 1A fluorescent per channel
- Incorporates a software selectable network burden and C-Bus system clock
- A maximum of 10 units may be connected to any C-Bus network
- Incorporates an inbuilt 200mA C-Bus power supply
- C-Bus Learn Enabled



L5504RVFC

4-Channel Changeover Relay, 250V a.c, Learn Enabled, Inbuilt 200mA C-Bus Power Supply

DIN Rail-Mounted 4-Channel Changeover - without C-Bus Power Supply

- 4-channel changeover relay with interlock features, DIN rail-mounted
- 8M DIN modules wide
- Dimensions 144mm x 85mm x 65mm
- Used for control of air conditioning systems (ON/OFF, low, medium and high) and shutter or blind control (UP/DOWN)
- The unit can be simply wired to achieve electrical interlocking, for use where outputs are all mutually exclusive
- Rated at 10A resistive, 5A incandescent/inductive, 1A fluorescent per channel
- Incorporates a software selectable network burden and C-Bus system clock
- A maximum of 100 units may be connected to any C-Bus network
- Draws 18mA from C-Bus when mains is not connected
- C-Bus Learn Enabled



L5504RVFCP

4 Channel Changeover Relay, 250V a.c, No Inbuilt C-Bus Power Supply

DIN Rail-Mounted Single-Channel Shutter Relay

- Single channel relay for the direct control of motorised blinds, curtains or shutters via C-Bus
- DIN rail-mounted, 2M wide
- Dimensions 36 x 93mm x 63mm
- Allows UP/DOWN and stop control
- A maximum of 80 units may be connected to a C-Bus network
- Powered from C-Bus, draws 18mA
- C-Bus Learn Enabled
- Optional remote mounting enclosure available (catalogue number 5501RE)



L5501RBCP
C-Bus Shutter Relay, 250V a.c.,
No Inbuilt C-Bus Power Supply



5501RE
Remote Mounting Enclosure,
Suits C-Bus Shutter Relay

DIN Rail-Mounted Single-Channel Fan Control Relay

- Single channel relay for the direct control of ceiling sweep fans
- Capacitor control (utilise capacitor supplied with fan)
- Inbuilt capacitor bay
- High temperature rated (to 70°C)
- DIN rail-mounted, 3M wide
- Dimensions 53 x 93mm x 65mm
- Up to 3-speed control of fan
- Programmable labels for fan speed broadcasted onto C-Bus
- Powered from C-Bus, draws 18mA
- Optional remote mounting enclosure available, catalogue number 5501FRE



L5501RFCP
C-Bus Fan Control Relay, 250V
a.c., No Inbuilt C-Bus Power
Supply



5501FRE
Remote Mounting Enclosure,
Suits C-Bus Fan Control Relay

C-Bus Output Units

Relay Units

Inline Single-Channel Relay

- Features 1-channel of 250V a.c. switching
- Dimensions 198mm x 42mm x 39mm
- Suitable for incandescent, inductive and fluorescent switching up to a maximum load of 10A
- A maximum of 100 units may be connected to any C-Bus network
- Does not draw any current from C-Bus network when mains power is connected



5101R
1-Channel Relay 250V a.c.
10A Inductive Load

Inline Single-Channel Relay - with Cord Set

- Features 1-channel of 250V a.c. switching
- Dimensions 198mm x 42mm x 39mm
- Prewired with terminated C-Bus cable and terminated double insulated mains cable
- Suitable for incandescent, inductive and fluorescent switching up to a maximum load of 10A
- A maximum of 100 units may be connected to any C-Bus network
- Does not draw any current from C-Bus network when mains power is connected



5101RC
1-Channel Relay 250V a.c. 10A
Inductive Load, with Cord Set

Inline 2-Channel Relay

- Features 2 channels of 250V a.c. switching (voltage free)
- Dimensions 198mm x 42mm x 39mm
- Suitable for incandescent, inductive and fluorescent switching up to a maximum load of 10A per channel
- A maximum of 100 units may be connected to any C-Bus network
- Does not draw any current from C-Bus network when mains power is connected



5102RVF
2-Channel Relay 250V a.c.,
10A Inductive Per Channel

Extra Low Voltage 8-Channel Relay

- 8 x single-pole, double-throw (changeover) relays
- Powered from C-Bus, draws 32mA
- Contacts rated 2A (AC3) @ 30V a.c./d.c.
- Relays can be operated in pairs
- Local override buttons
- High temperature rated (to 50°C)
- IP5x rated enclosure (dustproof)
- Removable terminals



L5108RELVP
8-Channel Extra Low Voltage
Relay 30V a.c./d.c. 2A Per
Channel

C-Bus Output Units

Infrared Output Units

Infrared Transmitter Output Units

- Transmit IR codes to third party devices
- Capable of broadcasting IR messages through 2 IR output channels (via 3.5mm mini audio mono sockets)
- Single or dual-head emitter leads (ordered separately) are connected to the output jacks (catalogue numbers 8050LD and 8050/2LD)
- Programmed via the high-speed programming cable (catalogue number 5100HSCU, ordered separately)
- The installer has the facility to modify the stored codes using Windows-based application software
- Store a library of commonly used IR codes
- The infrared controller is based on the standard range of C-Bus 4-button wall switches
- Available in White Electric
- Draws 32mA from the C-Bus network

2000 Series



5034NIRT
2-Channel Infrared
Transmitter Unit,
2000 Series Wall
Plate

Pictured: White

Accessories



5100HSCU
High-Speed
Programming
Cable for C-Bus
2-Channel
Infrared
Transmitter Unit.

Classic C2000 Series



C5034NIRT
2-Channel Infrared
Transmitter Unit,
Classic C2000
Series Wall Plate

Pictured: White



5100RP
Infrared Code
Learning Unit.
Required for
learning third party
infrared codes.
Not included in
the software code
library.

Slimline SC2000 Series



SC5034NIRT
2-Channel Infrared
Transmitter Unit,
Slimline SC2000
Series Wall Plate

Pictured: White



8050LD
IR Emitter Lead,
Single

Eclipse SL2000 Series



SL5034NIRT
2-Channel Infrared
Transmitter Unit,
Eclipse SL2000
Series Wall Plate

Pictured: White



8050/2LD
IR Emitter Lead,
Dual

C-Bus System Units and Accessories

C-Bus Wiser Home Controller MkII

- Purpose designed C-Bus system controller
- Resides as node on the Home network
- Single Ethernet (LAN) connection
- Wi-Fi client only (not a Wireless Access Point)
- Onboard C-Bus connection
 - Dual C-Bus (internal) connections on one single physical C-Bus connection
 - Can be used with external CNI if no physical C-Bus connection is available
- User interface on PC (via Web Browser)
- HDMI connection for user interface on a display monitor
 - Support for CEC codes through HDMI
- USB sockets and SD card slot
 - USB keyboard and mouse
 - Digital audio files for C-Bus Ripple
 - Storage of surveillance images
- Onboard memory for storage of images, logs etc.
- Scene and scheduling capabilities onboard
- Full Logic Engine capabilities onboard
- Control devices such as lighting, multi-room audio, HVAC, blinds and irrigation
- Allows remote access to re-program Wiser and C-Bus from outside the home/building
- Future integration with many IP based devices
- C-Bus Multi-Room Audio (MRA) support with onboard Ripple server and client
- Support for DHCP (client)
- Supports fixed IP address
- Support for DYNDNS services
- Support for NTP with client definable server locations
- Power Over Ethernet (POE) support
- SAMBA support
- Support for User and Location profiles
- Support for 20 channels of power monitoring and logging
- Comprehensive Wiser diagnostics functionality
- Multiple installation options; on a desktop or with AV equipment, on shelving or in an equipment rack and also wall mounting (using keyhole points)
- User interface on portable devices such as mobile phones and web tablets (via dedicated Android and iOS Apps) providing complementary control of native C-Bus on-wall devices

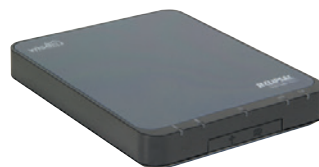

5200WHC2
C-Bus Wiser Home
Controller MkII

Wiser Home Control MkII System Architecture

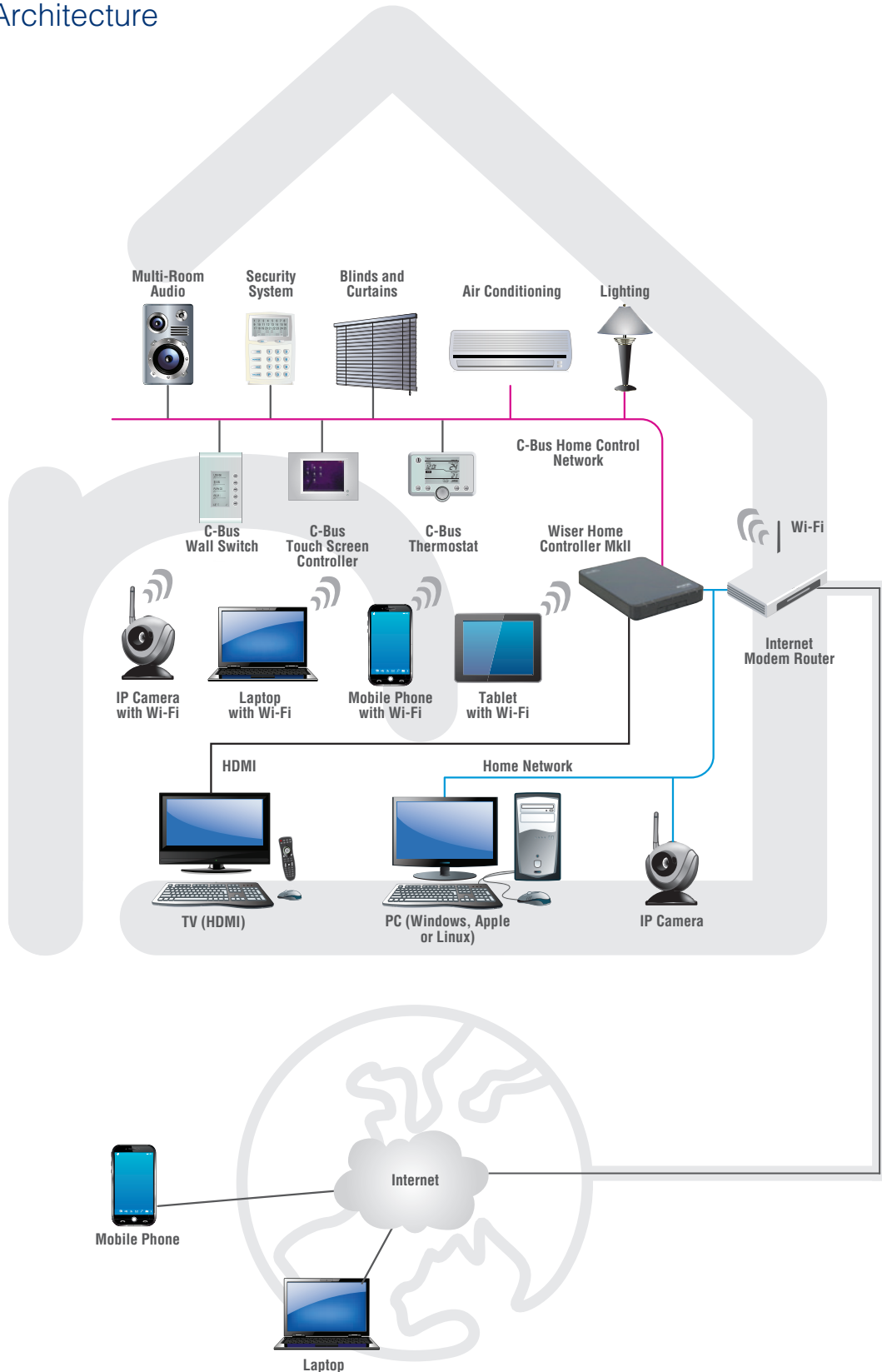

C-Bus System Units and Accessories

Pascal Automation Controller

- Provides extended conditional and real-time event programming for C-Bus
- Programming downloaded directly to the unit
- Connects directly to C-Bus (can act as a PC interface)
- Powered from C-Bus
- 4M DIN modules wide
- 2 x RS-232 ports for third party device control
- A scheduling tool allows time-based events to be programmed into the unit
- A scene programming tool allows installers to quickly and easily program scenes into the unit
- A programming wizard provides a GUI based method for creating basic logic programs
- More complex programs are produced by advanced users utilising the free-form text programming method
- Programming language based on the standard Pascal computer language, enhanced by Clipsal with specific commands related to C-Bus control
- The language supports commands such as:
 - conditional logic (if, then, and, or, not, etc.)
 - flow control (for, repeat, while)
 - variables (integer, real, Boolean, character, string)
 - control and monitor C-Bus group addresses
 - control and monitor C-Bus scenes
 - C-Bus tag names
 - serial (RS-232) input/output.



5500PACA
C-Bus Pascal
Automation
Controller

Current Measurement Unit and Current Transformer (CT)

- Measures and reports a circuit's instantaneous electrical power consumption over C-Bus
- Current monitoring is performed via a split core current transformer (CT)
- 4-channel unit (measure up to 4 electrical circuits per unit)
- Display energy use on C-Bus 6.4" Colour Touch Screen, Schedule Plus, HomeGate software and Wisier Home Control
- Raises C-Bus alerts and warning messages based on predefined thresholds
- Control electrical devices based on predefined thresholds (load shed)
- Can provide confirmation that electrical devices are operating as expected
- DIN rail mounted, 4M wide
- C-Bus supply voltage: 15–36V d.c. @ 18mA (does not provide power to the C-Bus network)
- CT is split core type and measures current between 0–80A (supplied separately)



5504CMU
C-Bus Current Measurement
Unit, 4-Channel



5100CT80
0A-80A 2-Wire Split Core CT



C-Bus BACnet Gateway

- C-Bus to BACnet Gateway hardware interface
- Allows exchange of information between C-Bus and a building management system (BMS) based on the BACnet protocol
- One full C-Bus lighting application is supported
- BACnet values supported: analogue read, analogue write and binary read
- Supplied preconfigured
- Supplied with an enclosure, C-Bus PC Interface and BACnet gateway power supply



5000BACNET
C-Bus BACnet
Gateway

C-Bus System Units and Accessories

C-Bus DMX Gateway

- C-Bus to DMX-512-A Gateway
- Map 12 C-Bus group addresses and levels to multiple combinations of DMX slot addresses
- Master device for transmission only (must be in position 1 on DMX network)
- Powered from C-Bus, draws 50mA
- DIN rail mounted, 4M wide
- Supplied with 300mm DMX cable



5500DMX
C-Bus DMX
Gateway

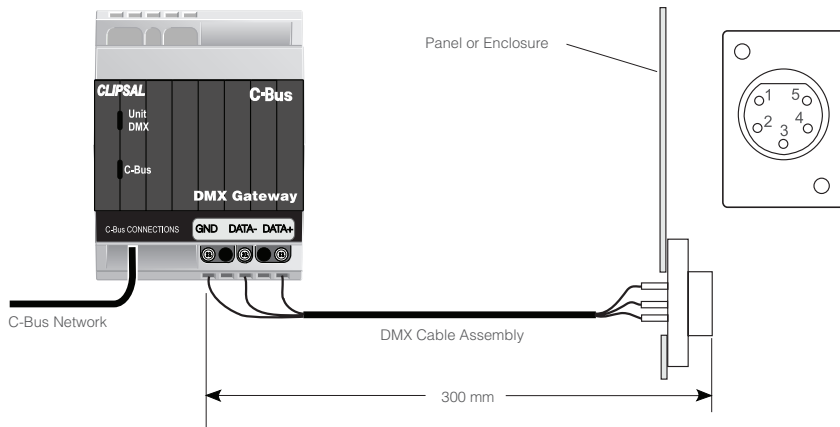

Signal name	Wire Colour	XLR-5 Connector
Ground (GND)	Shield	pin 1
Control Data Minus 1-	White/Blue Stripe	pin 2
Control Data Plus 1+	Blue/White Stripe	pin 3
Not Used		pin 4
Not Used		pin 5

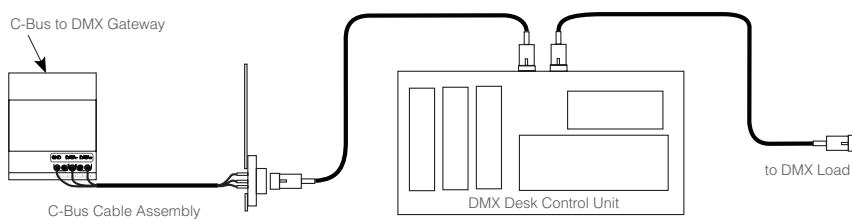

0–10V Analogue Output Unit

- Analogue output module, DIN rail mounted
- 4M DIN modules wide
- Requires a 240V a.c. connection
- Dimensions 72mm x 85mm x 65mm
- Can either source or sink current and is used to drive most types of 0–10V electronic dimmable ballasts
- The unit provides 4 independent output channels
- Powered from C-Bus and requires 18mA at 15–36V d.c. for correct operation
- Draws 18mA from the C-Bus when mains is not connected
- C-Bus Learn Enabled



L5504AMP
4-Channel
Analogue Output,
0–10V

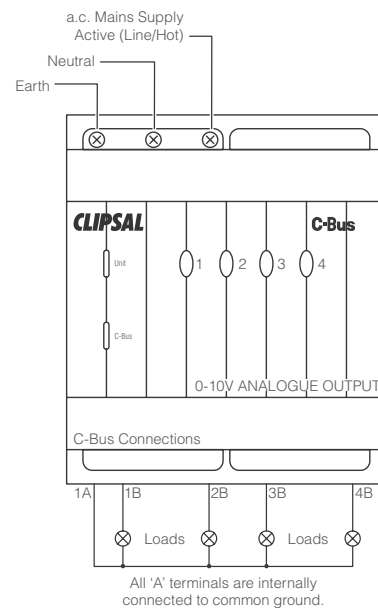
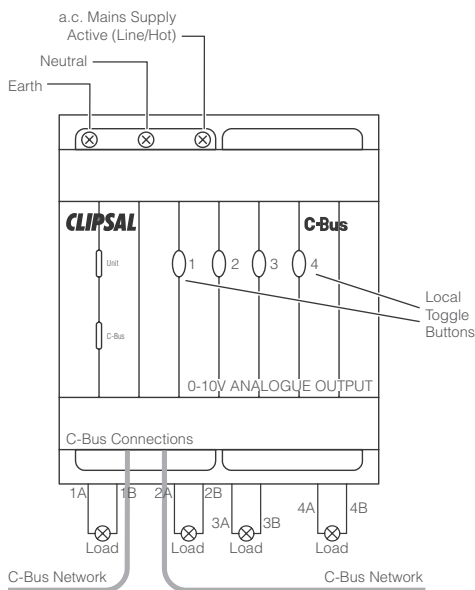

C-Bus System Units and Accessories

C-Bus DALI Gateway

- C-Bus to DALI Gateway, DIN rail mounted
- 4M DIN modules wide
- Dimensions 72mm x 85mm x 65mm
- Supports DALI lamp and ballast failure information over to the C-Bus network
- Capable of controlling up to 2 DALI networks
- Supports DALI group addresses, short addresses and scenes the DALI global (broadcast) address
- A remote switch input is included to turn all DALI output channels to the ON or OFF states, irrespective of the current state of C-Bus, including no C-Bus
- Incorporates C-Bus clock and network burden
- Up to 50 DALI Gateways can be connected to a single C-Bus network
- Draws 32mA from a C-Bus network



5502DALI
C-Bus DALI Gateway

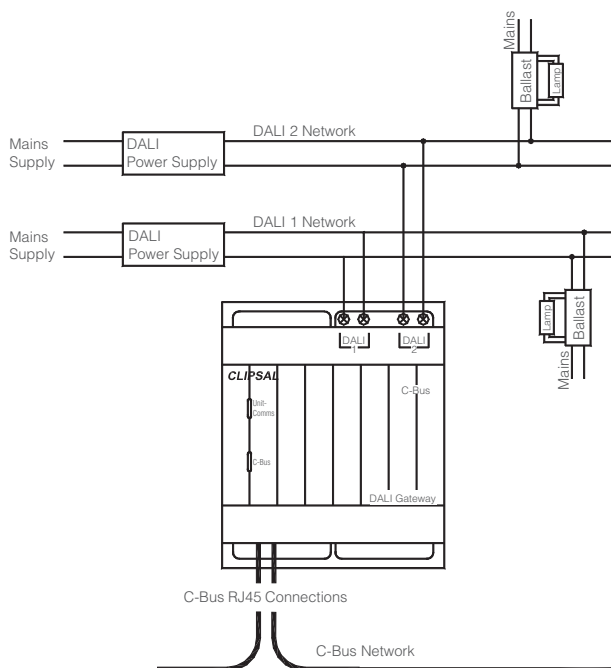

C-Bus DALI Gateway - with DALI Power Supplies

- C-Bus to DALI Gateway, DIN rail mounted
- 4M DIN modules wide
- Dimensions 72mm x 85mm x 65mm
- Supports DALI lamp and ballast failure information over to the C-Bus network
- Capable of controlling up to 2 DALI networks
- Supports DALI group addresses, short addresses and scenes the DALI global (broadcast) address
- A remote switch input is included to turn all DALI output channels to the ON or OFF states, irrespective of the current state of C-Bus, including no C-Bus
- Incorporates C-Bus clock and network burden
- Up to 50 DALI Gateways can be connected to a single C-Bus network
- Draws 32mA from a C-Bus network
- Supplied with two 1M DIN DALI power supply modules

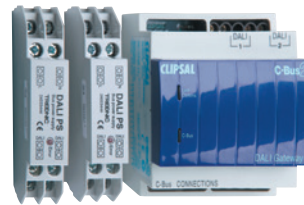

5502DAL2PS
C-Bus DALI Gateway Plus
Two DALI Power Supplies

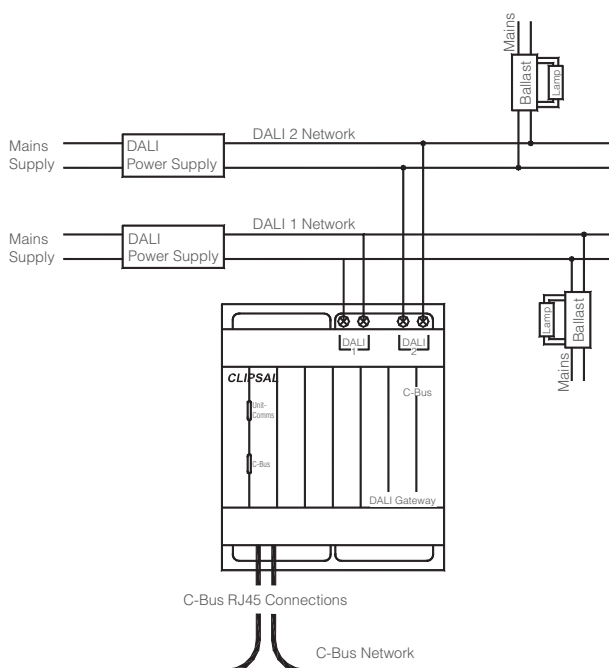

C-Bus System Units and Accessories

C-Bus PC Interface

- C-Bus PC interface, DIN rail mounted
- 4M DIN modules wide
- Dimensions 72mm x 85mm x 65mm
- Features 2 connections to C-Bus (2 x RJ45 sockets)
- Features 3 connections to RS232 (2 x RJ45 and 1 x DB9 sockets)
- Draws 32mA from a C-Bus network



5500PC
C-Bus PC Interface

C-Bus PC Interface - USB

- C-Bus PC interface, DIN rail mounted
- 4M DIN modules wide
- Dimensions 72mm x 85mm x 65mm
- Features 2 connections to C-Bus (2 x RJ45 sockets)
- Features 1 connection to USB (1 x type B socket)
- Draws 32mA from a C-Bus network



5500PCU
C-Bus USB PC Interface

C-Bus Power Supply

- C-Bus power supply, DIN rail mounted
- 4M DIN modules wide
- Dimensions 72mm x 85mm x 65mm
- Supplies 350mA at 18–36V d.c. to the C-Bus network
- Each power supply supports approximately 18 standard C-Bus units
- Up to 5 power supplies may be used on any single C-Bus network



5500PS
C-Bus Power Supply, 350mA

C-Bus Network Bridge

- C-Bus network bridge, DIN rail mounted
- 4M DIN modules wide
- Dimensions 72mm x 85mm x 65mm
- Provides a 2-way C-Bus to C-Bus network interface
- Draws 18mA from a C-Bus network



5500NB
C-Bus Network
Bridge

C-Bus Ethernet Network Interface

- C-Bus Ethernet network interface, DIN rail mounted
- 4M DIN modules wide
- Dimensions 72mm x 85mm x 65mm
- Provides a 2-way C-Bus to Ethernet network interface
- Allows C-Bus commands to be distributed via a 100Base-TX or 10Base-T Ethernet (TCP/IP) network
- Features 2 x C-Bus RJ45 connections and 1 x Ethernet RJ45 connection
- The unit requires an external 6–12V d.c. power supply unit (supplied)



5500CN2
C-Bus Ethernet
Network Interface

C-Bus Inline Ethernet Network Interface

- C-Bus Ethernet network interface, inline
- Provides a 2-way C-Bus to Ethernet network interface
- Allows C-Bus commands to be distributed via a 100Base-TX or 10Base-T Ethernet (TCP/IP) network
- Features 1 x C-Bus terminal block and 1 x Ethernet RJ45 connection
- The unit requires an external 5–24V d.c. power supply unit (supplied with 24V d.c. power supply unit)
- 24V d.c., 1.25A power supply unit
- Suits C-Bus Wisser Home Controller MkII and C-Bus Inline Network Interface



5100CN2
C-Bus Inline
Ethernet Network
Interface

Power Supply 24V d.c., 1.25A

- 24V d.c., 1.25A power supply unit
- Suits C-Bus Wisser Home Controller MkII and C-Bus Inline Network Interface



5100P24/1250
Power Supply
24V d.c. 1.25A

C-Bus System Units and Accessories

C-Bus Network Analyser

The Network Analyser is a tool used to measure various C-Bus system parameters:

- power available
 - clock signal present
 - excess voltage
 - add/remove burden
 - excess cable indication.
- Dimensions 60.5mm x 120mm x 30.3mm
 - Measures capacitance, burden, clock signal and network voltage
 - The network analyser is powered from C-Bus and supplied with leads



5100NA
C-Bus Network
Analyser

C-Bus Network Monitor

- C-Bus network monitor, DIN rail mounted
- 4M DIN modules wide
- Dimensions 72mm x 85mm x 65mm
- Activates C-Bus remote ON override in the event of a C-Bus network failure
- Passive device, does not transmit any data onto the network
- Draws 18mA from a C-Bus network



5500NMA
C-Bus Network
Monitor

Cat. 5e Shutter Socket

- Pink modular Cat. 5e RJ45 Shuttered Socket
- Suits C-Bus installations
- Easily identify C-Bus sockets

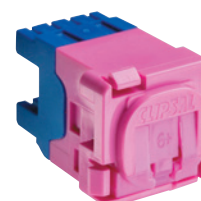

30RJ45SMA5SH,PK
Pink Modular Cat.
5e RJ45 Shuttered
Socket

C-Bus Cable

- 4-pair, Category 5, unshielded cable with a unique outer colour sheath specifically designed for the C-Bus system
- A maximum of 1000 metres of cable is permitted on any one C-Bus network
- 2 pairs are used for the C-Bus connection; C-Bus positive (blue + orange) and C-Bus negative (blue/white + orange/white)
- The C-Bus cable must be segregated from the mains cable in C-Bus installations
- C-Bus cable has a mains-rated low smoke zero halogen (LSZH) outer sheath
- Suitable for use inside electrical enclosures
- Available in both solid and stranded conductors



5005C305B
C-Bus Cat. 5,
4-Pair, UTP Cable,
305 Metres, Solid
Conductors

5005C305BST
C-Bus Cat. 5, 4-Pair,
UTP Cable, 305
Metres, Stranded
Conductors

C-Bus Network Burden

- C-Bus network RJ45 hardware burden
- Supplied in pack of 10



5500BUR
C-Bus Network
Burden

C-Bus Software

C-Bus Toolkit Software

C-Bus Toolkit software is a PC-accessible C-Bus network configuration and customer solution programming utility. It allows the installer to:

- connect directly to an installer C-Bus network via a C-Bus PC interface unit to synchronise logical and physical C-Bus customer site data
- configure the C-Bus network to define the C-Bus architecture of the customer site and ensure C-Bus units can communicate with each other
- program and commission the customer solution
- save, backup and restore sites. C-Bus Toolkit has a database for creating and storing customer site programming as projects.

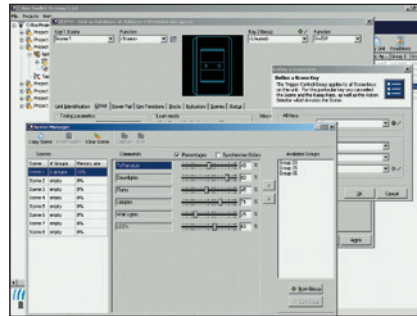

C-Bus Software Installer Dongle

The C-Bus Software Installer Dongle is a valuable installer tool for creating/commissioning projects using C-Bus Schedule Plus, HomeGate software and C-Bus OPC Server software. The dongle is time restricted and allows the software to operate in 'normal' mode for anywhere between 48 to 72 hours per use (the software then returns to Evaluation/Demo mode). The installer dongle is compatible with future software releases.



5000SDINST/1
Installer Dongle for C-Bus
Software, Unlimited Networks

HomeGate Software

The HomeGate application software provides a powerful, but simple to use interface to C-Bus via a standard PC. HomeGate provides scheduling, manual control and monitoring of a domestic C-Bus system from a PC running Windows 98, 2000, NT, ME or XP. HomeGate comprises project editor, real-time monitoring and control, a real time scheduler, security and access control and Internet access. It also includes help and support documentation.

A HomeGate USB dongle must be purchased to unlock the software from an evaluation version to a full working version.



5000SDHG2/4
2 Network Licence Dongle
for HomeGate



5000SDHG10/4
10 Network Licence Dongle
for HomeGate

C-Bus Software

Schedule Plus Software

Schedule Plus application software provides a powerful and easy use interface to C-Bus via a standard PC. Schedule Plus has been developed specifically for commercial and industrial applications. It provides scheduling, manual control and monitoring of a C-Bus system from a PC running Windows 98, 2000, NT, ME or XP. A Schedule Plus USB dongle must be purchased to unlock the software from an evaluation version to a full working version.



5000SDSP2/4
2 Network Licence Dongle
for Schedule Plus



5000SDSP10/4
10 Network Licence Dongle
for Schedule Plus



5000SDSPU/4
Unlimited Network Licence
Dongle for Schedule Plus

C-Bus OPC Server Software

The C-Bus OPC Server provides an interface between third party software (OPC Clients) and a C-Bus System. The C-Bus OPC Server acts as a gateway for transmitting C-Bus lighting type application information between third party building management systems (such as Honeywell, Johnson, etc.) or Process Control Presentation (SCADA) systems and a C-Bus system.

A C-Bus OPC Server USB dongle must be purchased to unlock the software from an evaluation version to a full working version.

Alternatively, the C-Bus OPC Server is able to recognise licenses manufactured by CITECT (currently only product versions based on the CITECT SCADA Version 7 platform and later are supported).

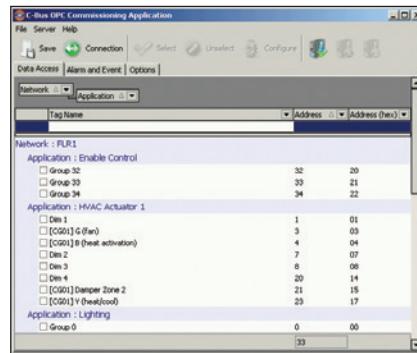

5000SDOPC2/1
2 Network Licence Dongle
for C-Bus OPC Server



5000SDOPC10/1
10 Network License Dongle
for C-Bus OPC Server



5000SDOPCU/1
Unlimited Network License
for C-Bus OPC Server

C-Bus Software

PICED Software

Programming Interface for C-Bus Embedded Devices (PICED) is used to configure the following devices to meet the user's requirements:

- C-Touch Black and White MKII Touch Screen Controller
- C-Touch Spectrum Colour Touch Screen Controller
- C-Touch 6.4" Colour Touch Screen Controller
- Pascal Automation Controller (PAC)
- Wisir Home Controller.

The PICED software features include:

- ability to display many components on many pages
- scenes for controlling many loads together
- schedules for automatic control of loads
- access control to provide security
- irrigation control
- widget manager for Wisir project creation.

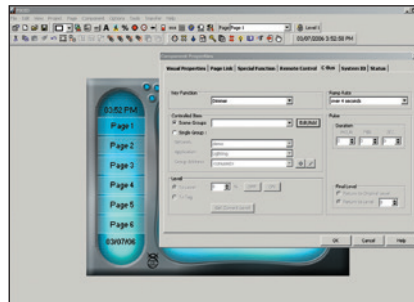

MARPA Software

Multi-Room Audio Rapid Programming Application (MARPA) software is used to configure the C-Bus Multi-Room Audio Matrix Switcher unit. It requires the use of a USB port on the PC to connect to the Matrix Switcher. MARPA software requires the C-Bus Toolkit to be installed. Configure audio sources, audio zones and infrared control.

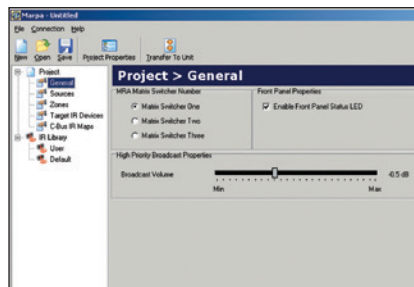

CIRCA Software

C-Bus Infrared Commissioning Software Application (CIRCA) software is used to commission C-Bus Infrared Devices (5034NIRT). The software allows the user to select IR codes and assign them to particular output channels on an infrared device and make associations between IR codes and C-Bus events. This is achieved by using the C-Bus USB Programming Cable (5100HSCU). The user can import IR device files created by the 5100RP Infrared Reader device. CIRCA software requires that C-Bus Toolkit is installed.

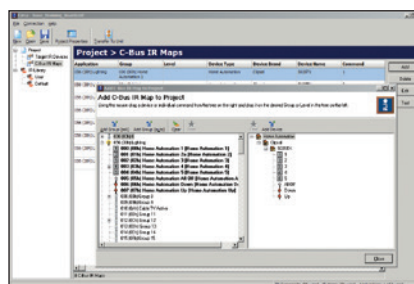

C-Bus Multi-Room Audio System Overview

C-Bus Multi-Room Audio

The C-Bus Multi-Room Audio system allows users to listen to and control audio sources from convenient locations around the home. The system is both simple to install and easy to use. The system has been designed utilising digital audio distribution technology (developed by Clipsal), in conjunction with Clipsal C-Bus core technology for system communication and integration. Clipsal's digital audio distribution technology allows for noise and interference-free audio reproduction, whilst the C-Bus technology allows the audio products to be seamlessly integrated and used with all existing C-Bus products. For example, volume can be controlled from the same C-Bus switch or touch screen that controls lighting.

In addition, the system allows any input audio source to be made available in any audio zone. Changes to the input audio source can easily be made by the user from a local C-Bus device at any time, regardless of where the audio source equipment (e.g. MP3 player) is physically located. It is compatible with most audio sources and it accommodates standard stereo line level analogue inputs, as well as digital audio TOSLINK inputs. Infrared signals from handheld remote controls can be routed through the system by connecting IR targets and emitters. IR commands can also be stored by the system and activated by programmed C-Bus commands.

The C-Bus Multi-Room Audio system allows a number of different system layout options. This flexibility accommodates for a wide range of customer needs and installation requirements. Two example schematics are shown opposite.

Option A

This basic option allows a single audio source to be available to a number of C-Bus Audio Amplifiers and controlled from convenient locations around the home (via any combination of C-Bus input devices). This option requires one Cat. 5 cable for the audio distribution. This cable is cascaded between each audio amplifier.

Option B

This option allows more flexibility. Multiple audio sources are made available to all audio zones, with all the audio sources selectable on a zone-by-zone basis via C-Bus Input Devices. This option requires a separate (star wired) Cat. 5 audio cable to each audio amplifier in a zone.



	Gold	Pink	Red/Black	Green
Cable Guide				
	Standard Speaker Cable	C-Bus Cat. 5 Cable	Line Level Stereo Audio Cable	Cat. 5 Cable for Digital Audio

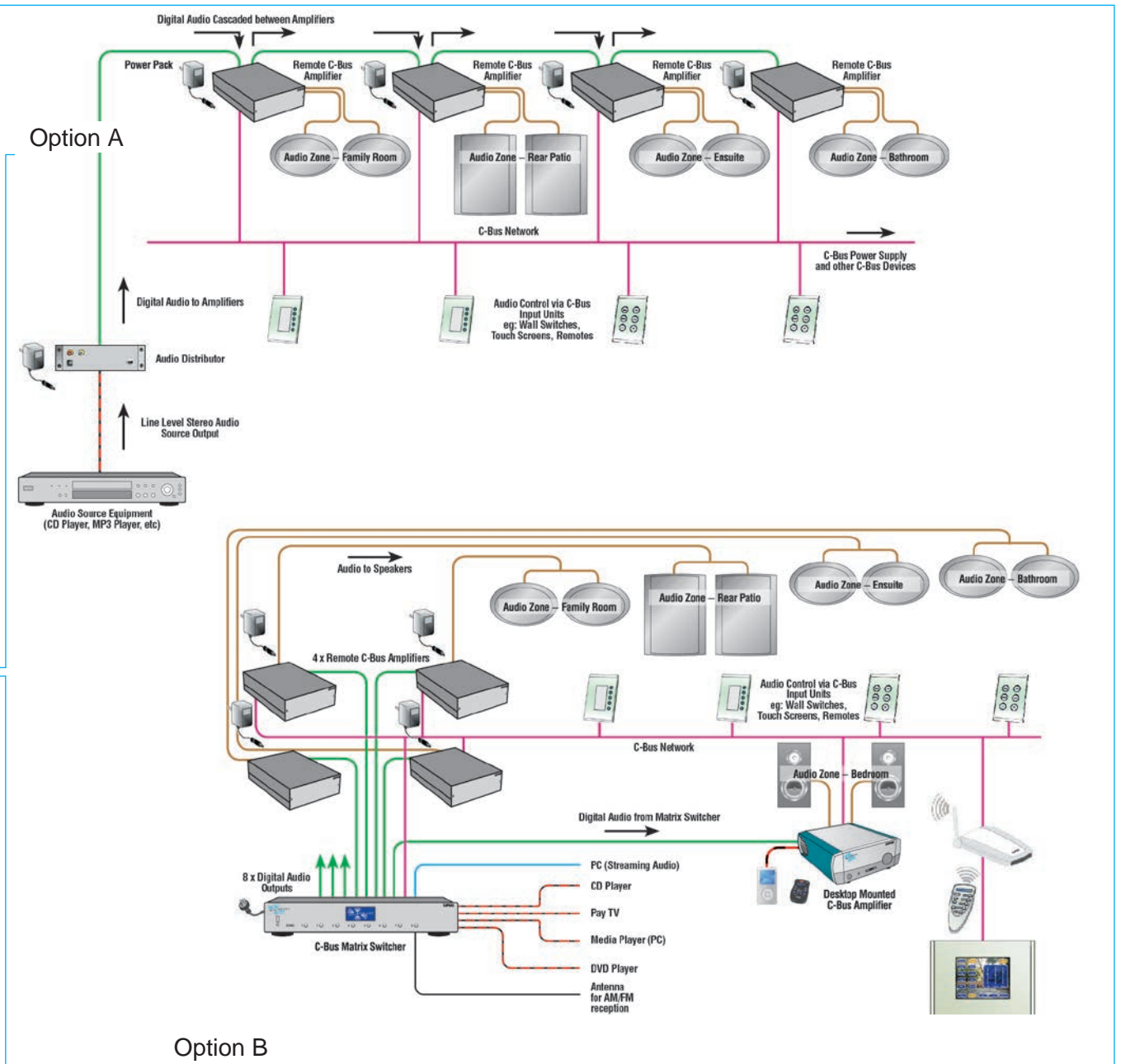

C-Bus Multi-Room Audio System Overview

Audio Matrix Switcher

- Digital audio distribution technology, for noise free audio reproduction
- Stream digital audio from a host PC running C-Bus Ripple Software (deluxe model only)
- 4 stereo analogue audio source inputs
- Onboard dual AM/FM tuners
- Audio sources switched via any C-Bus input device or via the control panel on the front of the matrix switcher
- 8 digital audio zone outputs (~45m for each star wired output)
- Supports audio scenes (8 scenes containing 8 zones)
- Cat. 5 cable connection between matrix switcher and amplifiers
- 2 mono annunciation inputs
- Voice annunciation of channel changes (selectable)
- 1 fibre optic SPDIF input (digital audio compatible)
- 1 custom digital input to allow cascading of units or for connecting an audio distribution unit giving 1 additional stereo analogue input
- C-Bus infrared output (2 zones) for third party equipment control
- Reticulated IR support
- User interface consisting of LCD display and tactile feedback switches
- C-Bus messages control selection of input/output routing
- Contains a C-Bus PC interface
- C-Bus supply voltage: 15–36V d.c. @ 22mA (does not provide power for C-Bus network)
- Configuration set up through USB
- Control via C-Bus input devices, such as C-Bus Wall Switches, Touch Screens, etc.
- Field upgradeable via USB port
- Dimensions: 436mm x 288mm x 80mm
- Designed to be installed where audiovisual equipment is located i.e. AV cabinet or rack



560884/2E

Deluxe Audio Matrix Switcher, C-Bus Enabled, 4 Stereo Audio Input Sources, Streaming Audio and 8 Digital Audio Output Sources

560884/2

Standard Audio Matrix Switcher, C-Bus Enabled, 4 Stereo Audio Input Sources and 8 Digital Audio Output Sources



5600EC

C-Bus Audio Matrix Switcher streaming upgrade module, suits standard C-Bus Audio Matrix Switcher

Audio Distribution Unit

- Distributes a single stereo audio source to C-Bus Audio Amplifiers via a digitised signal over Cat. 5 cable
- Does not require any C-Bus programming
- 1 stereo analogue audio input source
- 1 digital audio output (cascadable to multiple zones)
- Output can be looped between C-Bus Audio Amplifiers
- Dimensions: 165mm x 50mm x 40mm



560011
Audio Distribution Unit, 1 Stereo
Audio Input Source, 1 Digital
Output Source



5600P24/500AU
External Power Supply for Audio
Distribution Unit, Switch Mode,
24V d.c., 500mA (only required
if 560011 used to provide an
additional digital input for matrix
switcher)

C-Bus Multi-Room Audio System Overview

Audio Amplifiers

- Used in conjunction with the C-Bus Audio Matrix Switcher or the C-Bus Audio Distribution Unit
- Controllable via C-Bus input devices, such as C-Bus Wall Switches, Touch Screens and Wisier Home Controller
- Volume, bass, treble, balance controlled by C-Bus input devices
- Quiet digital audio design
- Stereo 25W RMS per channel. Remote and desktop mounted units (when power supply used) or stereo 10W RMS per channel. Remote mounted unit
- Can be cascaded off one digital audio Cat. 5 input
- Repeater function - digital audio pass through capability (default on)
- Pre-amp output stage for connecting to a third party power amplifier (25W RMS per channel amplifiers only)
- Desktop amplifier includes power ON/OFF, mute, volume and source select buttons; and an infrared target for remote control. Also includes 3.5mm stereo headphone jack
- Desktop amplifier supports dynamic control via long presses of source select buttons on front panel
- 4 x 10W per channel amplifiers can be joined together for installation on a 19" equipment rack tray
- Signal source either:
 - distributed digital
 - locally connected line-level analogue
 - fibre-optic (TOSlink) SPDIF (16bit, 48kHz).
- IR target connection for reticulated IR support
- High efficiency, ~70% at full power
- Dimensions (desktop 25W RMS per channel): 181mm x 216mm x 75mm
- Dimensions (remote 25W RMS per channel): 175mm x 212mm x 71mm
- Dimensions (remote 10W RMS per channel): 120mm x 158mm x 40mm
- C-Bus Supply Voltage: 15–36V d.c. @ 22mA



560125D/2
25W/Channel (RMS) Stereo Audio Amplifier, C-Bus Enabled, Desktop Mount Version



560125R/2
25W/Channel (RMS) Stereo Audio Amplifier, C-Bus Enabled, Remote Mount Version



560110R
10W/Channel (RMS) Stereo Audio Amplifier, C-Bus Enabled, Remote Mount Version

Audio Amplifier Accessories



560100E
Blank Filling Enclosure where
480mm width is required, suits
10W/Channel Remote Amplifier



560011BT
Bluetooth Receiver Module for
streaming digital audio from
portable devices. Line level
audio output



560110MB
Mounting Bracket to suit
10W/Channel Remote Amplifier



560125MB
Mounting Bracket to suit
25W/Channel Remote Amplifier



5600P24/1250AU
Power Supply to suit
10W/Channel Remote Amplifier



5600P24/3750AU
External Power Supply
for 25W/Channel Audio
Amplifier, Switch Mode,
24V d.c., 3.75A



5600P24H3750A
External Power Supply for Audio
Amplifier, Switch Mode, 24V d.c.
72W Continuous Output Power,
Ambient Temperature Rating:
60°C (140°F) @ 3A Output

C-Bus Multi-Room Audio System Overview

Premium Audio Speakers

- High-quality audio reproduction — perfect for home theatre, multi-room audio and outdoor audio applications
- Flush-mount design ensures only the front face of the speaker is visible and is flush with the ceiling or wall
- In-ceiling and in-wall speakers come complete with back boxes to maximise and control bass response, while keeping out dust
- Outdoor speakers are waterproof, containing aluminium grilles and mounting brackets plus marine grade stainless steel hardware



In-Ceiling Speakers - Krix Holographix

- Supplied as a pair
- 3", full range
- Sensitivity: 87dB
- Frequency response: 90Hz–20kHz
- Power handling: maximum 40W RMS amplifier power
- Impedance: 8 ohms
- Dimensions: 95mm diameter x 108mm deep (83mm diameter cut-out)



5600K01-WE
Krix Holographix Speakers (Pair), Circular, In-Ceiling, 3", Full Range

AVAILABLE COLOURS

In-Ceiling Speakers

White (WE)

In-Ceiling Speakers - Krix Hemispherix

- Supplied single
- 4", 2-way
- Sensitivity: 86dB
- Frequency response: 65Hz–20kHz
- Power handling: maximum 60W RMS amplifier power
- Impedance: 6 ohms
- Dimensions: 240mm diameter x 140mm deep
(205mm diameter cut-out)



5600K02-WE

Krix Hemispherix Speaker
(Single), Circular, In-Ceiling,
4" , 2-Way

In-Ceiling Speakers - Krix Atmosherix

- Supplied single
- 5", 2-way
- Sensitivity: 90dB
- Frequency response: 45Hz–20kHz
- Power handling: maximum 100W RMS amplifier power
- Impedance: 6 ohms
- Dimensions: 280mm diameter x 190mm deep
(247mm diameter cut-out)



5600K03-WE

Krix Atmosherix Speaker
(Single), Circular, In-Ceiling,
5" , 2-Way

AVAILABLE COLOURS

In-Ceiling Speakers

White (WE)

C-Bus Multi-Room Audio System Overview

In-Wall Speakers - Krix Ecliptix

- Supplied single
- 4", 2-way
- Sensitivity: 86dB
- Frequency response: 65Hz-20kHz
- Power handling: maximum 60W RMS amplifier power
- Impedance: 6 ohms
- Dimensions: 305mm high x 220mm wide x 100mm deep
- Cut-out: 276mm high x 188mm wide



5600K04-WE
Krix Ecliptix Speaker (Single),
Rectangular, In-Wall, 4", 2-Way

Outdoor Speakers - Krix Aquatix

- Supplied as a pair
- 5", 2-way
- Sensitivity: 87dB
- Frequency response: 70Hz-20kHz
- Power handling: maximum 80W RMS amplifier power
- Impedance: 8 ohms
- Marine grade waterproof



5600K06-WE, 5600K06-BK
Krix Aquatix Speakers (Pair),
Outdoor, Marine Grade
Waterproof, 5", 2-Way

Pictured: Black

Outdoor Speakers - Krix Tropix

- Supplied as a pair
- 6 1/2", 2-way
- Sensitivity: 87dB
- Frequency response: 55Hz-20kHz
- Power handling: maximum 100W RMS amplifier power
- Impedance: 8 ohms
- Marine grade waterproof



5600K07-WE, 5600K07-BK
Krix Tropix Speakers (Pair),
Outdoor, Marine Grade
Waterproof, 6 1/2", 2-Way

Pictured: Black

AVAILABLE COLOURS

In-Wall Speakers

White (WE)

Outdoor Speakers

Black (BK)

White (WE)

Multi-Room Audio Accessories

- Infrared accessories to suit C-Bus Multi-Room Audio System
- Supports infrared reticulation features of C-Bus Multi-Room Audio
- Range includes emitters and targets

Accessories



8050LD
IR Emitter Lead, Single



8050/2LD
IR Emitter Lead, Dual



8050ST
IR Shelf Target, with 1.8m Cable



8050TT
IR Tube Target, with 1.8m Cable



8050FT
IR Flat Target, with 1.8m Cable

C-Bus Wireless

For Australia and New Zealand

C-Bus Wireless Control System

The C-Bus Wireless product range incorporates a family of C-Bus Radio Frequency (RF) devices, including wall switches, plug adaptors, remote controls, battery operated wall switches and a gateway to Cat. 5 wired C-Bus.

C-Bus Wireless Wall Switches are designed to easily replace standard, 240V wall switches. They incorporate patented Clipsal technology and are 2-wire devices requiring no Neutral (240V a.c. active and load connections only).

All C-Bus Wireless units incorporate Clipsal C-Bus unique Learn mode functions for programming devices. Wall switches, plug adaptors and the gateway unit can also be programmed via the C-Bus Toolkit software. Multiple C-Bus Wireless units can be linked into a common network using Learn mode or the C-Bus Toolkit software.

Associations can be created between buttons on multiple units, so that a button pressed on one unit will operate a button on another (and the connected lights or other electrical devices).

C-Bus Wireless units include scene capabilities, which allow the user to perform a series of actions across multiple outputs by pressing a single button. For example, on arrival home a homeowner could use a scene to switch on lights in the hallway, kitchen and lounge, and also switch on a heater.

The diagrams (right) show two of the many possible basic C-Bus Wireless unit installations. Room A uses stand-alone units, which can be switched via the C-Bus Wireless remote control. Room B uses networked units where buttons on one unit can operate other units or trigger scenes.



Grouping C-Bus Wireless Units

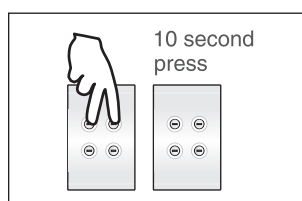

Step 1
Enter Learn mode

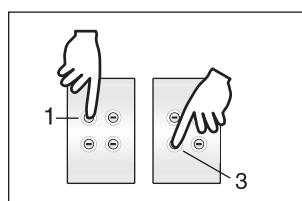

Step 2
Associate buttons between units and program button function

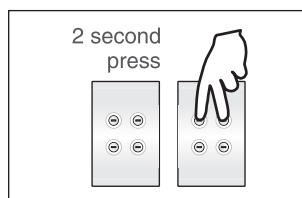

Step 3
Exit Learn mode

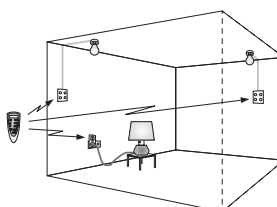

Room A
Stand-alone C-Bus Wireless Units

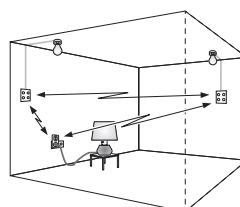

Room B
Networked C-Bus Wireless Units

Basic Operation

Buttons on a wireless wall switch or plug adaptor are organised in pairs that control the output channels (local control buttons). Remaining pairs (free buttons) are used to control outputs on other units when multiple C-Bus Wireless units are configured as part of a network. For example, the figure to the right shows a 6-button, 2-channel Saturn Wireless Dimmer Wall Switch. Its buttons perform the following functions:

- Buttons 1 and 2 control the first channel. A quick press on either button toggles the channel ON/OFF. A long press on buttons 1 or 2 dims DOWN/UP respectively.
- Buttons 3 and 4 control the second channel.
- Buttons 5 and 6 are unused when the unit is used as a stand-alone unit. They may be used to control outputs on other units when part of a multi-unit network.

When a C-Bus Wireless Wall Switch or Plug Adaptor unit is first installed, it functions as a stand-alone unit. In this basic default mode, the unit functions as a dimmer or switch, depending on the model.

C-Bus Wireless Plug Adaptors have 1 output channel (a single, 240V a.c. socket) and 2 buttons. Wall switch units are available in 1 or 2 output channel versions, with 2, 4, 6 or 8 buttons (8-button, Neo only). Each channel controls 1 or more lights or other electrical devices connected to its output.

Two Output Channels

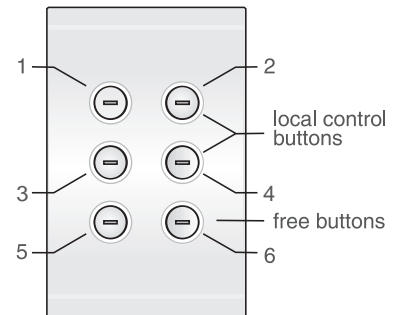

C-Bus Wireless

For Australia and New Zealand

C-Bus Wireless Networks

To experience the full capabilities of wireless operation, C-Bus Wireless units must be linked together to form a network. To communicate with each other, units within the same network should be located within 15 to 20m of each other. This distance depends on building materials used. Up to 30 units may be connected within the same C-Bus Wireless network.

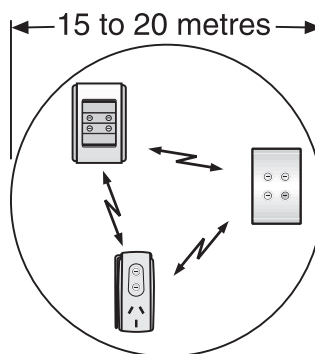

C-Bus Wireless Network Security

C-Bus Wireless units can optionally use 128-bit encrypted messages to communicate with each other. This results in a highly secure network.

Nearby C-Bus Wireless Networks

It is possible to have several separate networks present alongside each other without interfering, as each separate C-Bus Wireless network has an automatically assigned and unique 'house code'.

C-Bus Wireless Modes of Operation

C-Bus Wireless units have 5 major modes of operation:

- Stand-alone
- Simple remote controlled
- Networked
- Networked with remote
- Networked with Cat. 5 units

Programming a C-Bus Wireless Unit via C-Bus Toolkit Software

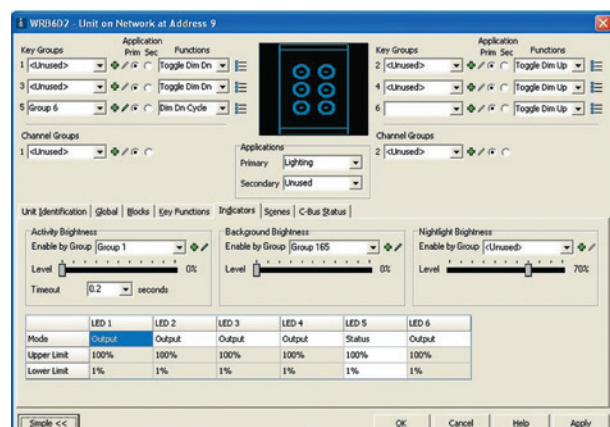

C-Bus Wireless

For Australia and New Zealand

Mode 1 Stand-Alone

In this mode, C-Bus Wireless Wall Switches and Plug Adaptors act as stand-alone dimmers or switches and make no use of the inbuilt wireless capabilities. No set-up is required for this mode, plug adaptors simply plug into the mains and wireless wall switches are installed in place of existing wall switches. The buttons on the units control the local dimming or switching channels of the unit only.

Mode 2 Simple Remote Controlled

In this mode, C-Bus Wireless Wall Switches and Plug Adaptors act as stand-alone dimmers or switches and a C-Bus Wireless Remote Control or battery-operated wall switch operate the units from a distance. This mode is simple to set up and is suitable for small installations where networking is not needed. In this mode the buttons on the wireless wall switch or plug adaptor control the local dimming or switching channels of the unit. The remote control or battery-operated wall switch is linked to buttons on the C-Bus wireless wall switch or plug adaptor using the Learn mode operation. No PC is required.

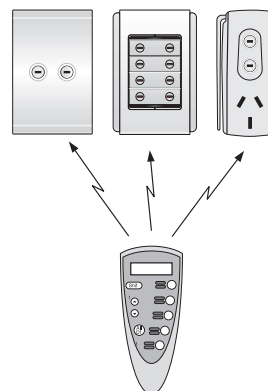

Mode 3 Networked

In this mode, C-Bus Wireless Wall Switches and Plug Adaptors act as dimmers or switches and multiple C-Bus Wireless units can be linked to each other with the C-Bus Wireless technology. This mode is simple to set up, and is suitable for more complex installations. In this mode, local control buttons control the dimming or switch channel of the unit and may also control other C-Bus Wireless units. Free buttons can control the dimmer or switch channels of other units via a C-Bus Wireless network established using Learn mode operations. The button function is set using Learn mode operation or using the C-Bus Toolkit software.

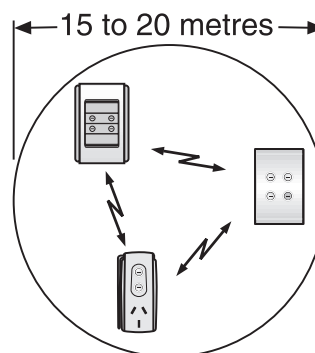

Mode 4 Networked with Remote

In this mode, C-Bus Wireless Wall Switches and Plug Adaptors act as dimmers or switches and multiple C-Bus Wireless units can be linked to each other with the C-Bus Wireless technology. Local control buttons control the dimming or switch channel of the unit and may also control other C-Bus Wireless units. Free buttons can control the dimmer or switch channels of other units via a C-Bus Wireless network established using Learn mode operations or C-Bus Toolkit software. Buttons on the wireless remote or battery-operated wall switch are linked to the C-Bus Wireless Wall Switch and Plug Adaptor buttons as desired.

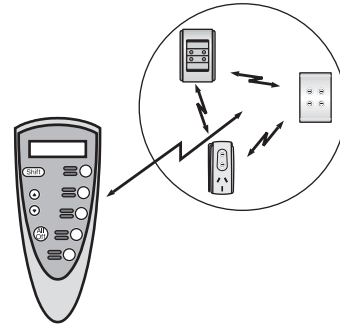

Mode 5 Networked with Cat. 5 Units

The C-Bus Wireless Gateway is used to link a C-Bus Wireless network to a C-Bus Cat. 5 wired network. It is functionally equivalent to a C-Bus Network Bridge. Using the Gateway, C-Bus Wireless and Cat. 5 networks can communicate and interact with each other. Both wireless and Cat. 5 networks use the same command structure and are 100% compatible.

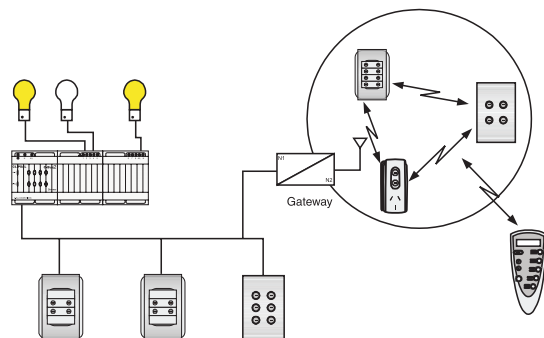

C-Bus Wireless

For Australia and New Zealand

C-Bus Wireless Wall Switch Range

- Allow existing 240V a.c. operated wall switches to be replaced with C-Bus Wireless Wall Switches containing C-Bus Wireless technology
- Communicate with other C-Bus Wireless devices using radio frequency wireless messaging and form a C-Bus Wireless network
- Switch buttons enable control of the load/s directly connected to the wall switch and can also control loads connected to other C-Bus Wireless devices
- Each switch button can be programmed to function as an ON/OFF switch, a dimmer or can issue a scene, as well as a number of other options
- Can be controlled via C-Bus Cat. 5 Wired Input Units (via a Gateway Unit), such as touch screens
- Unique C-Bus Wireless House Code
- 128-bit encrypted communications
- Two-wire connection – Active and load (no Neutral required)
- Programmable via C-Bus Learn mode or via C-Bus Toolkit software
- Available in 1-channel and 2-channel versions
- Leading edge and trailing edge dimming units, 1 channel 500VA and 2 channel 250VA per channel
- Relay unit rating: 1 channel 8A (fluorescent), and 2 channel 4A (fluorescent) per channel
- Available in Neo, Saturn and Modena styles

Wall Switches with Integral Relay Outputs - Saturn Series



5882R8F1AA
C-Bus Wireless Wall
Switch, 2-Button,
1-Channel Relay, 8A
(Fluorescent) Rating

Pictured: White



5884R8F1AA
C-Bus Wireless Wall
Switch, 4-Button,
1-Channel Relay,
8A
(Fluorescent) Rating

Pictured: Mid-
Brown



5884R4F2AA
C-Bus Wireless Wall
Switch, 4-Button,
2-Channel Relay, 4A
(Fluorescent) per
Channel Rating

Pictured: Mid-Brown



5886R8F1AA
C-Bus Wireless Wall
Switch, 6-Button,
1-Channel Relay,
8A (Fluorescent)
Rating

Pictured: Cream







5886R4F2AA
C-Bus Wireless Wall
Switch, 6-Button,
2-Channel Relay, 4A
(Fluorescent) per
Channel Rating

Pictured: Cream

AVAILABLE COLOURS

Saturn Series

-  White (GF)
-  Cream (380)
-  Mid-Brown (780)
-  Black (680)

C-Bus Wireless

For Australia and New Zealand

Wall Switches with Integral Relay Outputs - Modena Series



LHC2R8F1
C-Bus Wireless Wall Switch,
2-Button, 1-Channel Relay, 8A
(Fluorescent) Rating

Pictured: White



LHC4R8F1
C-Bus Wireless Wall Switch,
4-Button, 1-Channel Relay, 8A
(Fluorescent) Rating

Pictured: Black



LHC6R8F1
C-Bus Wireless Wall Switch,
6-Button, 1-Channel Relay, 8A
(Fluorescent) Rating

Pictured: White



LHC6R4F2
C-Bus Wireless Wall Switch,
6-Button, 2-Channel Relay,
4A (Fluorescent) per Channel
Rating

Pictured: Black



LHC4R4F2
C-Bus Wireless Wall Switch,
4-Button, 2-Channel Relay,
4A (Fluorescent) per
Channel Rating

Pictured: White

AVAILABLE COLOURS

Modena Series

- White (WH)
- Black (BK)

Modena 8000 Series Surrounds

- Platinum (M8000HC-PT)
- Charcoal (M8000HC-CC)
- Blue (M8000HC-DB)
- Red (M8000HC-RD)
- Champagne (M8000HC-CP)
- Gunmetal (M8000HC-GM)
- Chrome (M8000HC-CH)

Wall Switches with Integral Relay Outputs - Neo Series



5852R8F1AA
C-Bus Wireless Wall
Switch, 2-Button,
1-Channel Relay,
8A (Fluorescent)
Rating

Pictured: Battleship
Grey/Brushed
Aluminium



5854R8F1AA
C-Bus Wireless Wall
Switch, 4-Button,
1-Channel Relay,
8A (Fluorescent)
Rating

Pictured: Battleship
Grey/Brushed
Aluminium



5854R4F2AA
C-Bus Wireless Wall
Switch, 4-Button,
2-Channel Relay,
4A (Fluorescent) per
Channel Rating

Pictured: Battleship
Grey/Brushed
Aluminium



5858R8F1AA
C-Bus Wireless Wall
Switch, 8-Button,
1-Channel Relay,
8A (Fluorescent)
Rating

Pictured: Battleship
Grey/Brushed
Aluminium



5858R4F2AA
C-Bus Wireless Wall
Switch, 8-Button,
2-Channel Relay, 4A
(Fluorescent) per
Channel Rating

Pictured: Battleship
Grey/Brushed
Aluminium

AVAILABLE COLOURS

Neo Series

- White (WE)
- Cream (CM)
- Soft Grey (SG)
- Battleship Grey/Brushed Aluminium (GB)
- Black (BK)

C-Bus Wireless

For Australia and New Zealand

Wall Switches with Integral Leading Edge Dimmer Outputs - Saturn Series



5882D2L1AA
C-Bus Wireless Wall Switch, 2-Button, 1-Channel Leading Edge Dimmer, 500VA

Pictured: Black



5884D2L1AA
C-Bus Wireless Wall Switch, 4-Button, 1-Channel Leading Edge Dimmer, 500VA

Pictured: Mid-Brown



5884D1L2AA
C-Bus Wireless Wall Switch, 4-Button, 2-Channel Leading Edge Dimmer, 250VA per Channel

Pictured: Mid-Brown



5886D2L1AA
C-Bus Wireless Wall Switch, 6-Button, 1-Channel Leading Edge Dimmer, 500VA

Pictured: Cream







5886D1L2AA
C-Bus Wireless Wall Switch, 6-Button, 2-Channel Leading Edge Dimmer, 250VA per Channel

Pictured: Cream

AVAILABLE COLOURS

Saturn Series

-  White (GF)
-  Cream (380)
-  Mid-Brown (780)
-  Black (680)

Wall Switches with Integral Leading Edge Dimmer Outputs - Modena Series



LHC2D2L1
C-Bus Wireless Wall Switch,
2-Button, 1-Channel Leading
Edge Dimmer, 500VA

Pictured: White



LHC4D2L1
C-Bus Wireless Wall Switch,
4-Button, 1-Channel Leading
Edge Dimmer, 500VA

Pictured: Black



LHC6D2L1
C-Bus Wireless Wall Switch,
6-Button, 1-Channel Leading
Edge Dimmer, 500VA

Pictured: White



LHC6D1L2
C-Bus Wireless Wall Switch,
6-Button, 2-Channel Leading
Edge Dimmer, 250VA per
Channel

Pictured: Black



LHC4D1L2
C-Bus Wireless Wall Switch,
4-Button, 2-Channel Leading
Edge Dimmer, 250VA per
Channel

Pictured: White

AVAILABLE COLOURS

Modena Series

- White (WH)
- Black (BK)

Modena 8000 Series Surrounds

- Platinum (M8000HC-PT)
- Charcoal (M8000HC-CC)
- Blue (M8000HC-DB)
- Red (M8000HC-RD)
- Champagne (M8000HC-CP)
- Gunmetal (M8000HC-GM)
- Chrome (M8000HC-CH)

C-Bus Wireless

For Australia and New Zealand

Wall Switches with Integral Leading Edge Dimmer Outputs - Neo Series



5852D2L1AA
C-Bus Wireless Wall Switch, 2-Button, 1-Channel Leading Edge Dimmer, 500VA

Pictured: Battleship Grey/Brushed Aluminium



5854D2L1AA
C-Bus Wireless Wall Switch, 4-Button, 1-Channel Leading Edge Dimmer, 500VA

Pictured: Battleship Grey/Brushed Aluminium



5854D1L2AA
C-Bus Wireless Wall Switch, 4-Button, 2-Channel Leading Edge Dimmer, 250VA per Channel

Pictured: Battleship Grey/Brushed Aluminium



5858D2L1AA
C-Bus Wireless Wall Switch, 8-Button, 1-Channel Leading Edge Dimmer, 500VA

Pictured: Battleship Grey/Brushed Aluminium



5858D1L2AA
C-Bus Wireless Wall Switch, 8-Button, 2-Channel Leading Edge Dimmer, 250VA per Channel

Pictured: Battleship Grey/Brushed Aluminium

AVAILABLE COLOURS

Neo Series

- White (WE)
- Cream (CM)
- Soft Grey (SG)
- Battleship Grey/Brushed Aluminium (GB)
- Black (BK)

Wall Switches with Integral Trailing Edge Dimmer Outputs - Saturn Series



5882D2T1AA
C-Bus Wireless Wall
Switch, 2-Button,
1-Channel Trailing
Edge Dimmer,
500VA

Pictured: White



5884D2T1AA
C-Bus Wireless Wall
Switch, 4-Button,
1-Channel Trailing
Edge Dimmer,
500VA

Pictured: Mid-Brown



5884D1T2AA
C-Bus Wireless Wall
Switch, 4-Button,
2-Channel Trailing
Edge Dimmer,
250VA per Channel

Pictured: Mid-Brown



5886D2T1AA
C-Bus Wireless Wall
Switch, 6-Button,
1-Channel Trailing
Edge Dimmer,
500VA

Pictured: Cream







5886D1T2AA
C-Bus Wireless Wall
Switch, 6-Button,
2-Channel Trailing
Edge Dimmer,
250VA per Channel

Pictured: Cream

AVAILABLE COLOURS

Saturn Series

-  White (GF)
-  Cream (380)
-  Mid-Brown (780)
-  Black (680)

C-Bus Wireless

For Australia and New Zealand

Wall Switches with Integral Trailing Edge Dimmer Outputs - Modena Series



LHC2D2T1
C-Bus Wireless Wall Switch,
2-Button, 1-Channel Trailing
Edge Dimmer, 500VA

Pictured: White



LHC4D2T1
C-Bus Wireless Wall Switch,
4-Button, 1-Channel Trailing
Edge Dimmer, 500VA

Pictured: Black



LHC6D2T1
C-Bus Wireless Wall Switch,
6-Button, 1-Channel Trailing
Edge Dimmer, 500VA

Pictured: White



LHC6D1T2
C-Bus Wireless Wall Switch,
6-Button, 2-Channel Trailing
Edge Dimmer, 250VA per
Channel

Pictured: Black



LHC4D1T2
C-Bus Wireless Wall Switch,
4-Button, 2-Channel Trailing
Edge Dimmer, 250VA per
Channel

Pictured: White

AVAILABLE COLOURS

Modena Series

- White (WH)
- Black (BK)

Modena 8000 Series Surrounds

- Platinum (M8000HC-PT)
- Charcoal (M8000HC-CC)
- Blue (M8000HC-DB)
- Red (M8000HC-RD)
- Champagne (M8000HC-CP)
- Gunmetal (M8000HC-GM)
- Chrome (M8000HC-CH)

Wall Switches with Integral Trailing Edge Dimmer Outputs - Neo Series



5852D2T1AA
C-Bus Wireless Wall
Switch, 2-Button,
1-Channel Trailing
Edge Dimmer,
500VA

Pictured: Battleship
Grey/Brushed
Aluminium



5854D2T1AA
C-Bus Wireless
Wall Switch,
4-Button,
1-Channel Trailing
Edge Dimmer,
500VA

Pictured: Battleship
Grey/Brushed
Aluminium



5854D1T2AA
C-Bus Wireless Wall
Switch, 4-Button,
2-Channel Trailing
Edge Dimmer,
250VA per Channel

Pictured: Battleship
Grey/Brushed
Aluminium



5858D2T1AA
C-Bus Wireless Wall
Switch, 8-Button,
1-Channel Trailing
Edge Dimmer,
500VA

Pictured: Battleship
Grey/Brushed
Aluminium



5858D1T2AA
C-Bus Wireless Wall
Switch, 8-Button,
2-Channel Trailing
Edge Dimmer,
250VA per Channel

Pictured: Battleship
Grey/Brushed
Aluminium

AVAILABLE COLOURS

Neo Series

- White (WE)
- Cream (CM)
- Soft Grey (SG)
- Battleship Grey/Brushed Aluminium (GB)
- Black (BK)

C-Bus Wireless

For Australia and New Zealand

Saturn – Mounting Spacer



5080SD-BK
Mounting Spacer,
(Pack of 5)

Pictured: Black

Neo – Mounting Spacer

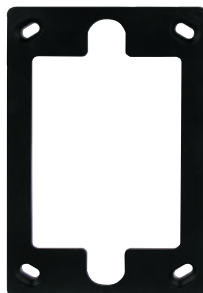

5050SD-BK
Mounting Spacer

Pictured: Black

AVAILABLE COLOURS

- White (WE)
- Cream (CM)
- Black (BK)
- Soft Grey (SG)

C-Bus Wireless Battery-Operated Wall Switches - Saturn Series

- Provides control of C-Bus Wireless Wall Switch or Plug Adaptor units remotely
- Provides control of C-Bus devices on a wired network via the C-Bus Wireless Gateway
- Battery operated
- Utilises radio frequency (RF) communication
- Available in 2-button and 6-button units (5 control buttons plus 1 ALL OFF button)
- ALL OFF button provides a convenient way to switch off all buttons associated with the battery-operated wall switch
- Control C-Bus groups and scenes
- 6-button unit incorporates a LED backlit screen for printed button labels
- 17m range (typical)



5882TXWMB
C-Bus Wireless Wall Switch, 2-Button, Battery-Operated

Pictured: Pure White



5886TXWMB-EB
C-Bus Wireless Wall Switch, 6-Button, Battery-Operated

Pictured: Espresso Black

AVAILABLE COLOURS

Saturn Series

- Pure White (PW)
- Espresso Black (EB)
- Ocean Mist (OM)

C-Bus Wireless

For Australia and New Zealand

C-Bus Wireless Plug Adaptors

- Allow devices normally plugged into 240V a.c. general purpose outlets (for example, lounge or bedside lamps, or AV equipment) to be controlled using C-Bus Wireless technology
- Communicate with other C-Bus Wireless devices (such as Wireless Wall Switches) using radio frequency wireless messaging and form a C-Bus Wireless Network
- C-Bus Wireless Plug Adaptors plug into existing power outlets and the device to be controlled via C-Bus Wireless then piggybacks into the Plug Adaptor. No additions or alterations to existing wiring are required
- Plug into a standard Australian and New Zealand general purpose electrical outlet
- Available in leading edge dimming and trailing edge dimming units, as well as a relay output version
- Integral, easily accessible control/override/programming buttons
- Can be controlled via C-Bus Cat. 5 wired input units (via a Gateway unit), such as touch screens
- Unique C-Bus Wireless House Code
- 128-bit encrypted communications
- Programmable via C-Bus Learn features or via C-Bus Toolkit software

Relay



5812R10F1AA
C-Bus Wireless Plug Adaptor,
1-Channel Relay, 10A



LHC2R10F1
C-Bus Wireless Plug Adaptor,
1-Channel Relay, 10A

Leading Edge Dimmer



5812D3L1AA
C-Bus Wireless Plug Adaptor,
1-Channel Leading Edge
Dimmer, 3A



LHC2D3L1
C-Bus Wireless Plug Adaptor,
1-Channel Leading Edge
Dimmer, 3A

Trailing Edge Dimmer



5812D2T1AA
C-Bus Wireless Plug Adaptor,
1-Channel Trailing Edge
Dimmer, 2A



LHC2D2T1
C-Bus Wireless Plug Adaptor,
1-Channel Trailing Edge
Dimmer, 2A

C-Bus Wireless

For Australia and New Zealand

C-Bus Wireless Remote Control Unit

- Allows control of buttons on C-Bus Wireless Wall Switch and Plug Adaptor units remotely
- Utilises radio frequency (RF) communication
- Does not need to be pointed directly at the unit being controlled
- Capable of controlling up to 10 separate wall switch or plug adaptor buttons
- A single button on a wall switch or plug adaptor can be controlled by up to 2 C-Bus Wireless Remote Controls
- Buttons are organised in 2 banks of 5 buttons. Banks are alternately selected by pressing the 'Shift' button
- UP/DOWN buttons allow dimming of the level associated with the last button selected (on dimmer units)
- ALL OFF button provides a convenient way to switch off all buttons associated with the remote control unit
- C-Bus Wireless groups and scenes can be controlled from the remote
- LCD screen and buttons incorporate a blue LED backlight
- Each control button incorporates a clear window for button labelling
- Supplied with pre-labelled stickers for identification of common areas i.e. kitchen, lounge, dining, etc.
- 20–25m range (typical)



5888TXBA
C-Bus Wireless
Handheld Remote
Control Unit with
Holder



5080TXC
C-Bus Remote
Control Holder
(Spare)



LHC8TXRF
C-Bus Wireless
Handheld Remote
Control Unit

C-Bus Wireless Gateway

- Allows seamless communication between a wired C-Bus network and a C-Bus Wireless network
- Desktop or wall-mounted
- A C-Bus Cat. 5 Cable connected to the wired C-Bus network is plugged into an RJ45 Socket at the rear of the Gateway
- Power for the Gateway is provided by the wired C-Bus network. No additional power source is required
- The connection to a C-Bus Wireless network is accomplished by a C-Bus Learn mode operation
- The connection to a C-Bus Cat. 5 wired network requires the use of the C-Bus Toolkit software
- The Gateway supports routing of messages into and through both wired and wireless networks
- Messages on each network (such as button presses) can be passed through to the adjacent network
- Remote switch function allows control of devices on a wired C-Bus network from C-Bus Wireless Battery-Operated Wall Switches or Remote Controls



5800WCGA
C-Bus Wireless
Gateway

C-Bus HomeSafe

Security Interface

C-Bus HomeSafe Security Interface

- C-Bus HomeSafe Security Interface suits 8-zone and 16-zone HomeSafe Alarm Panels
- Onboard, direct connection to C-Bus (no C-Bus PC Interface required)
- Supports the C-Bus Security Application command set
- Alarm events such as “armed”, “disarmed” and “alarm” can be used to initiate C-Bus commands, e.g. turn C-Bus controlled lighting ON/OFF
- Ability to map up to 16 alarm events to 16 C-Bus commands
- Ability to arm the security from C-Bus input device (e.g. Touch Screen Controller or Wall Switch)
- True 2-way communication with C-Bus

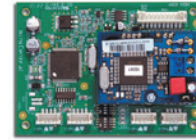

5400CB

C-Bus HomeSafe Security Interface, suits 8-Zone and 16-Zone Alarm Panels

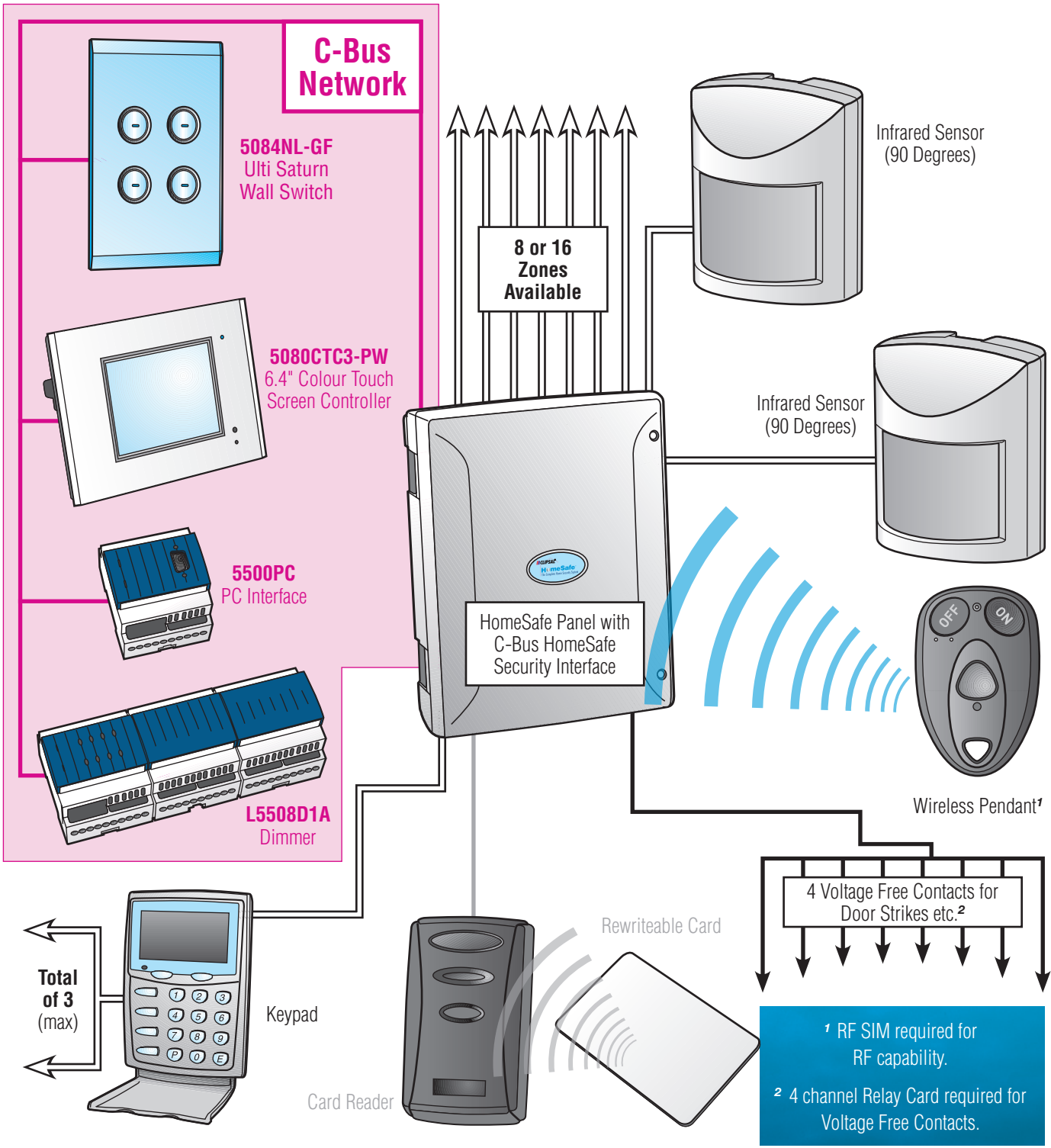

Clipsal C-Bus

Typical Schematics

Typical Basic Network



- 1) Each C-Bus network can be a maximum of 1000m
- 2) Each C-Bus network can have either a maximum of 100 devices or draw a maximum of 2 amp, whichever limit is reached first.

Typical Basic Network With Interfaces

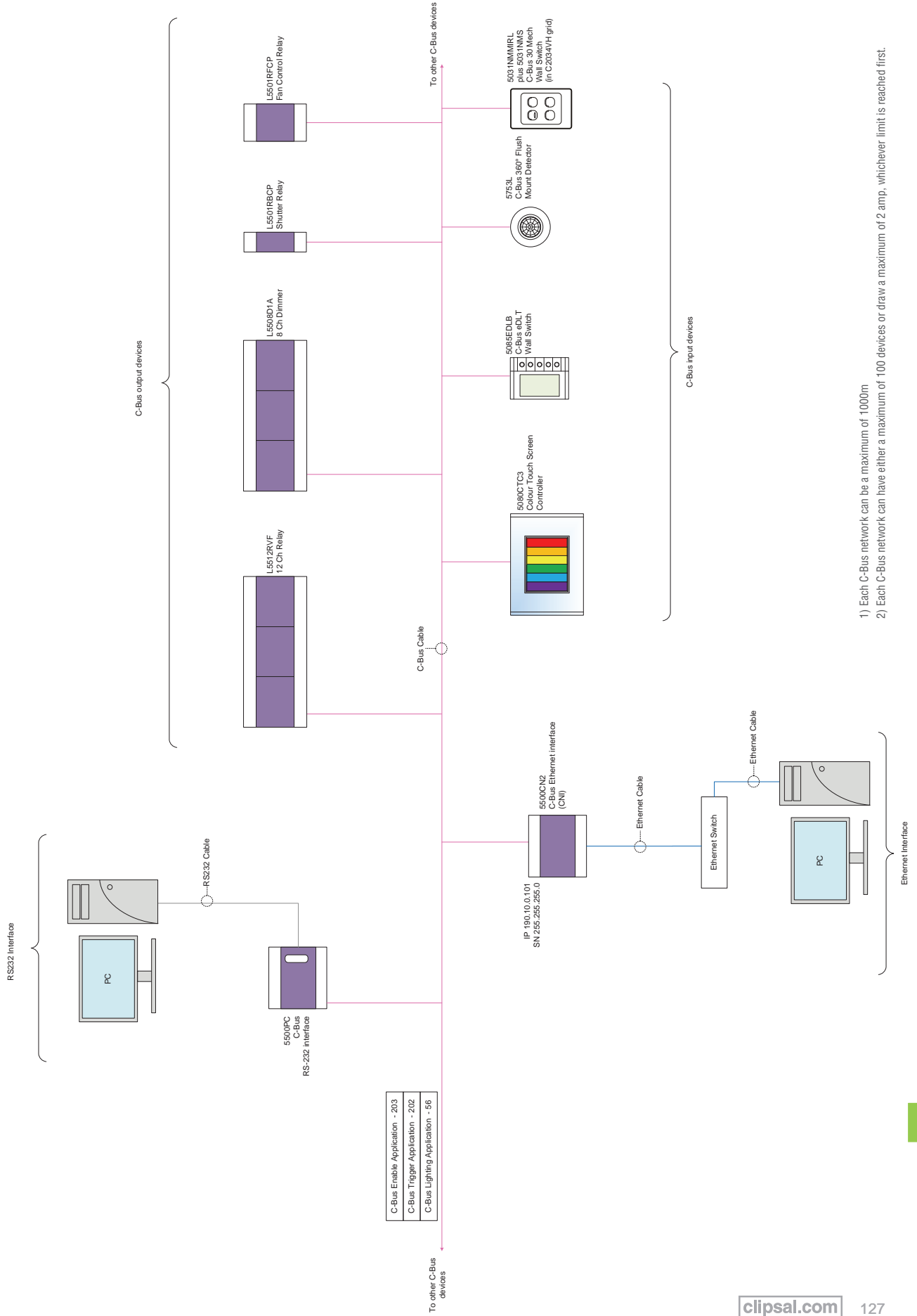

Clipsal C-Bus

Typical Schematics

Typical Network Joining

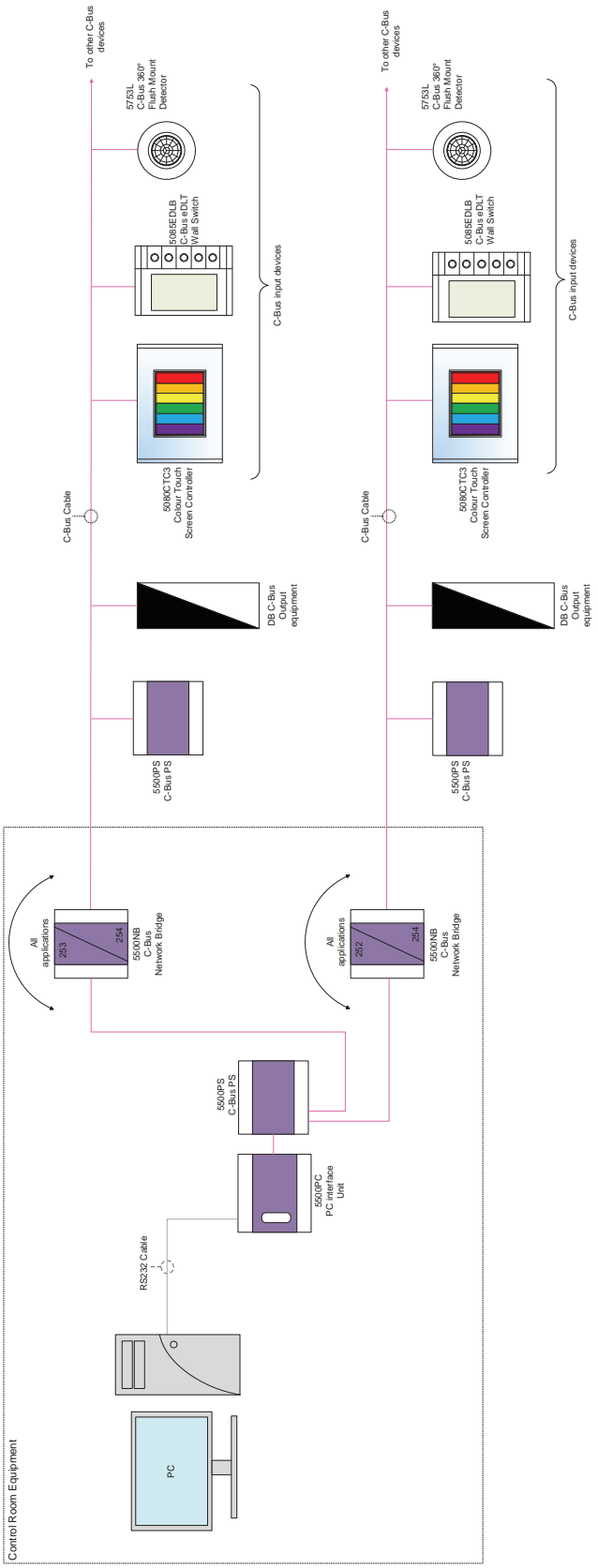

Typical Ethernet Backbone

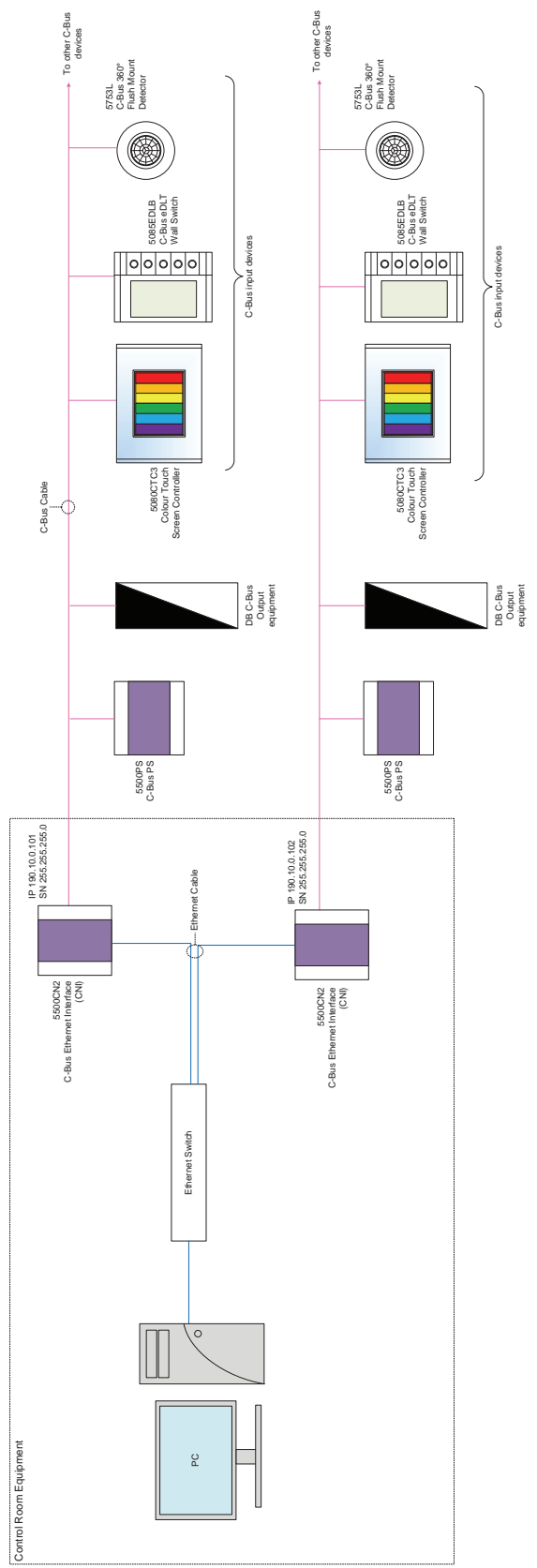

Typical Daisy Chain Networks

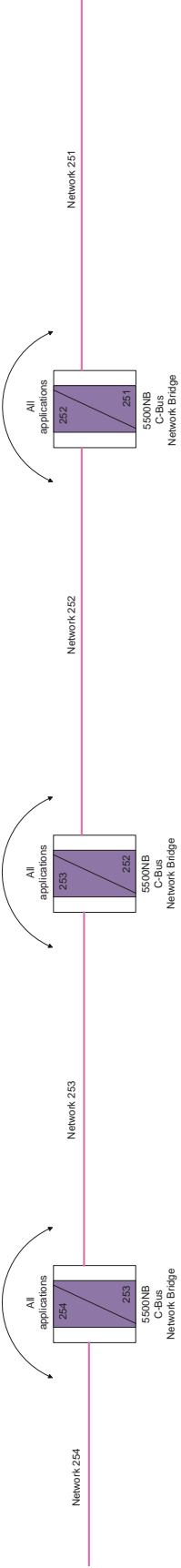

Clipsal C-Bus

Typical Schematics

Typical Home Network

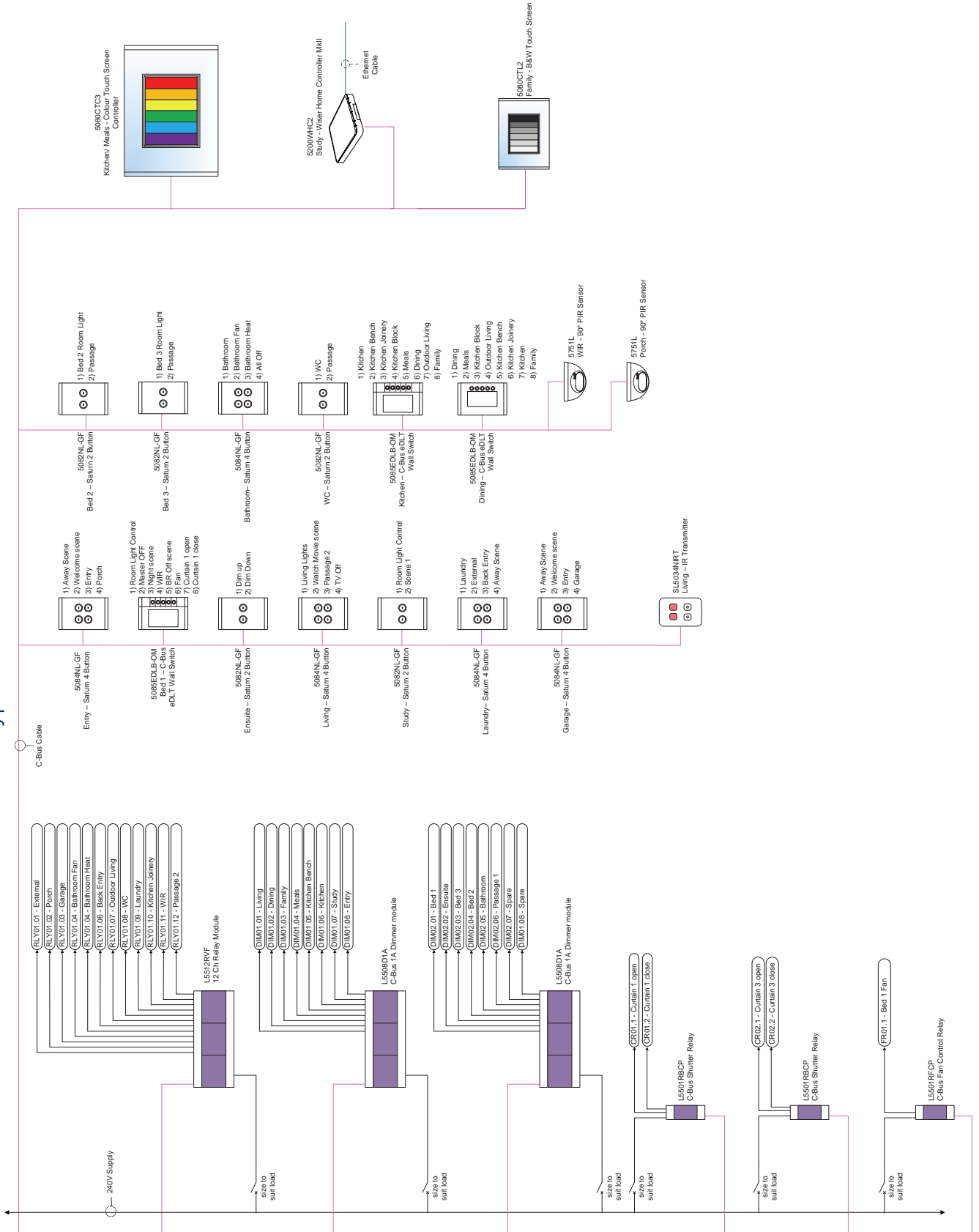

Typical Multi Storey Ethernet Backbone



1) All numbers are decimal

Clipsal C-Bus

Typical Schematics

Typical Multi Building Ethernet Backbone

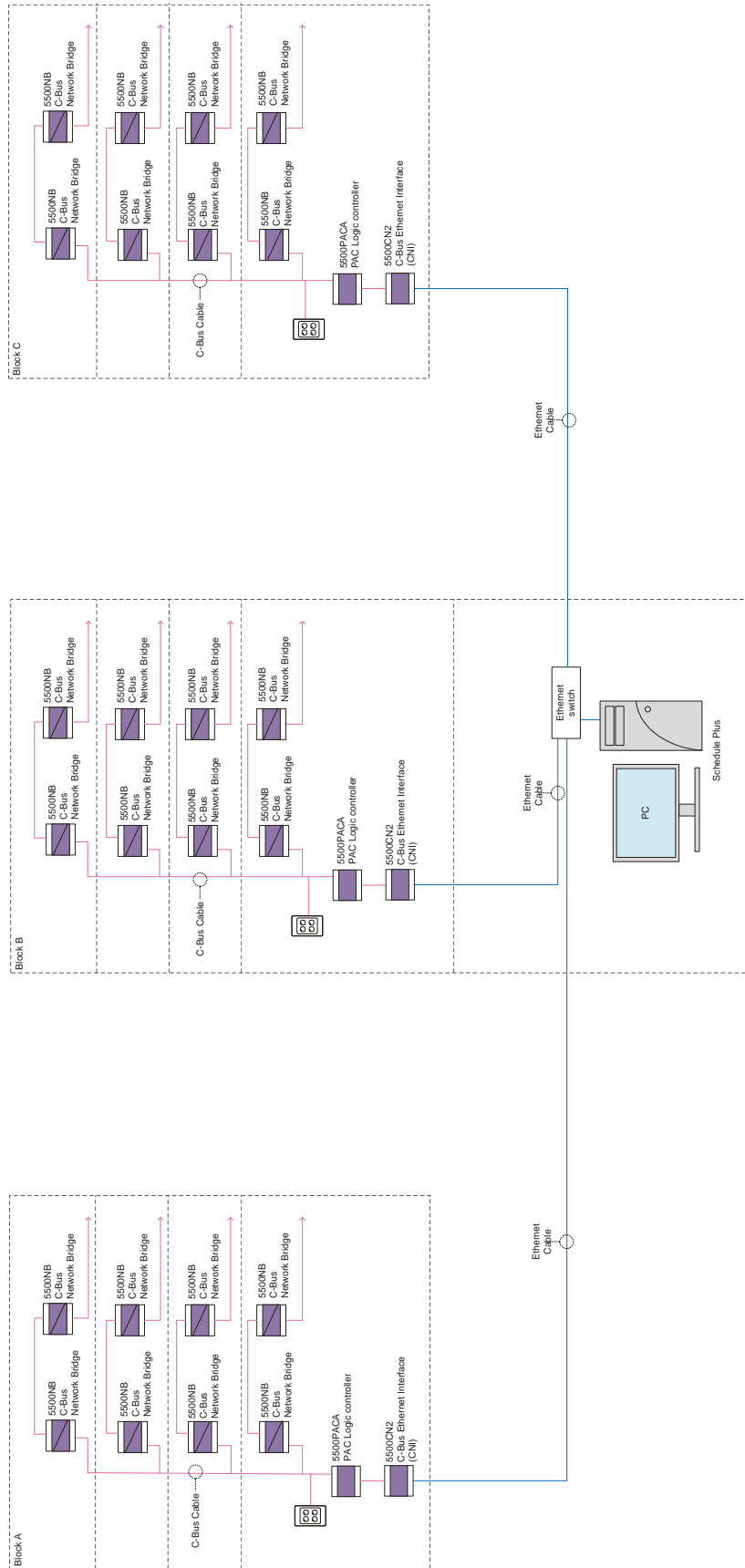

Option. Include a PAC and 4-gang as a minimum in each block as a fail-safe in the event Schedule Plus, PC or Network failure. Schedule Plus is set up a master, PAC as slave, with Schedule Plus sending a heart beat to the PAC. If PAC misses 3 consecutive heartbeats the PAC will become the master. 4-button switch can be used a master override for each floor

Typical Multi-Storey C-Bus Backbone



- 1) All numbers are decimal
- 2) A PC with Schedule Plus software installed on the backbone will provide the C-Bus networks with greater flexibility allowing for message routing between all networks

Clipsal C-Bus

Typical Schematics

Typical Fluorescent Dimming

The DALI Ballasts are to be addressed with DALI commissioning software connected directly to the DALI Bus, not via the C-Bus commissioning software. This software, and any associated hardware, is best provided by the ballast manufacturer thus preventing warranty disputes in the event of incorrect ballast operation.

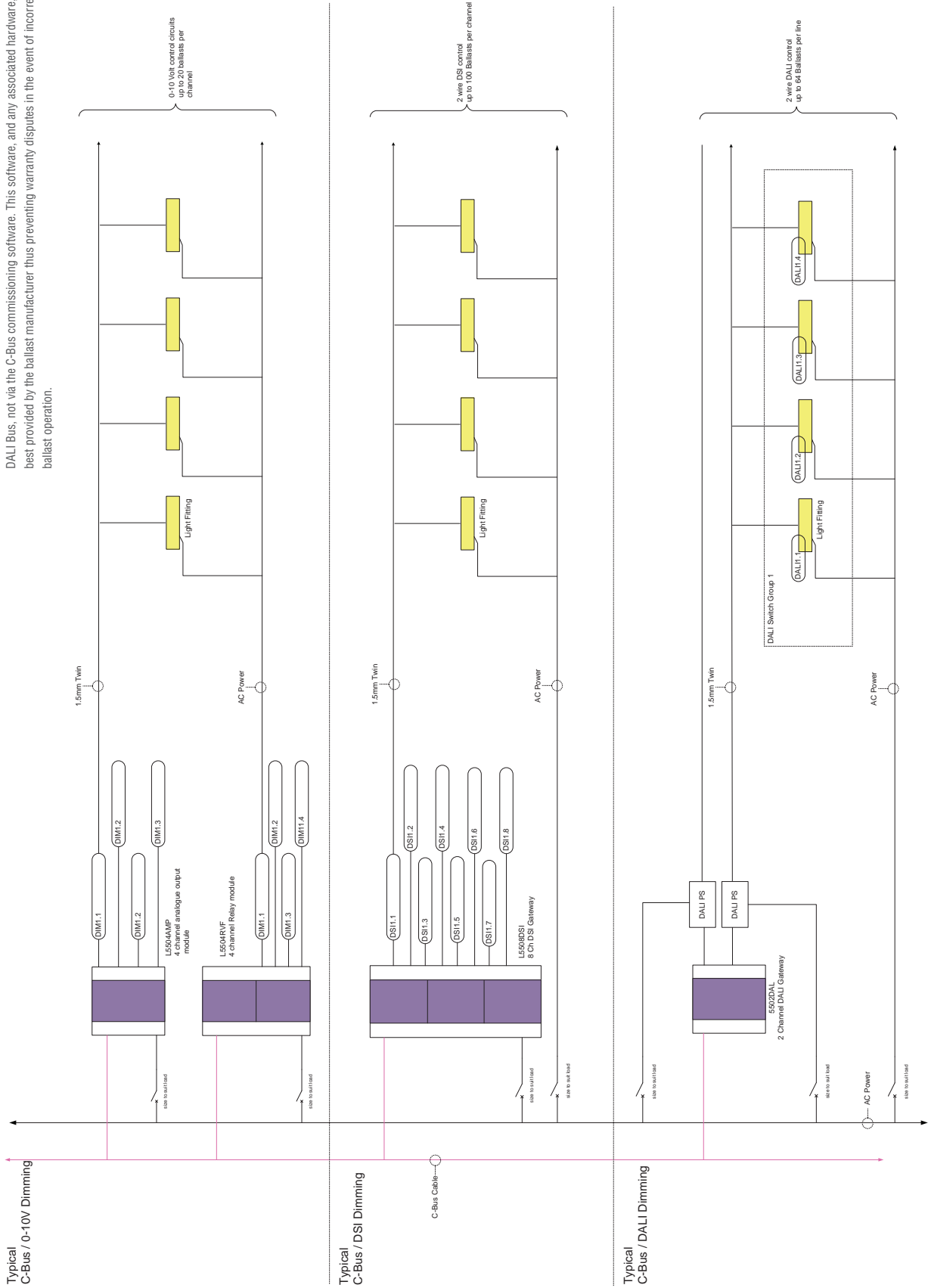

Typical RGB Control

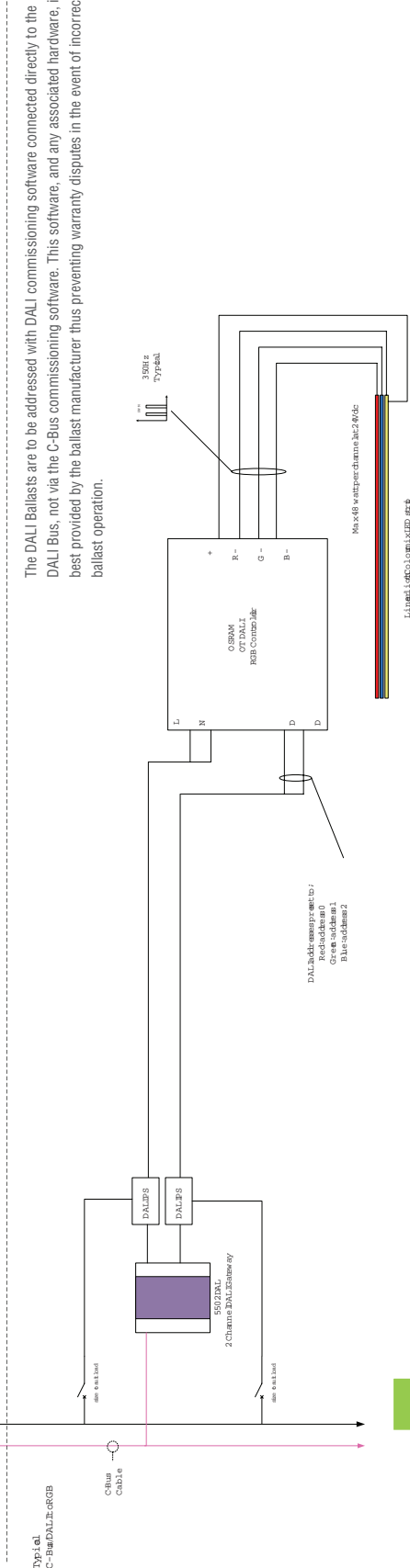
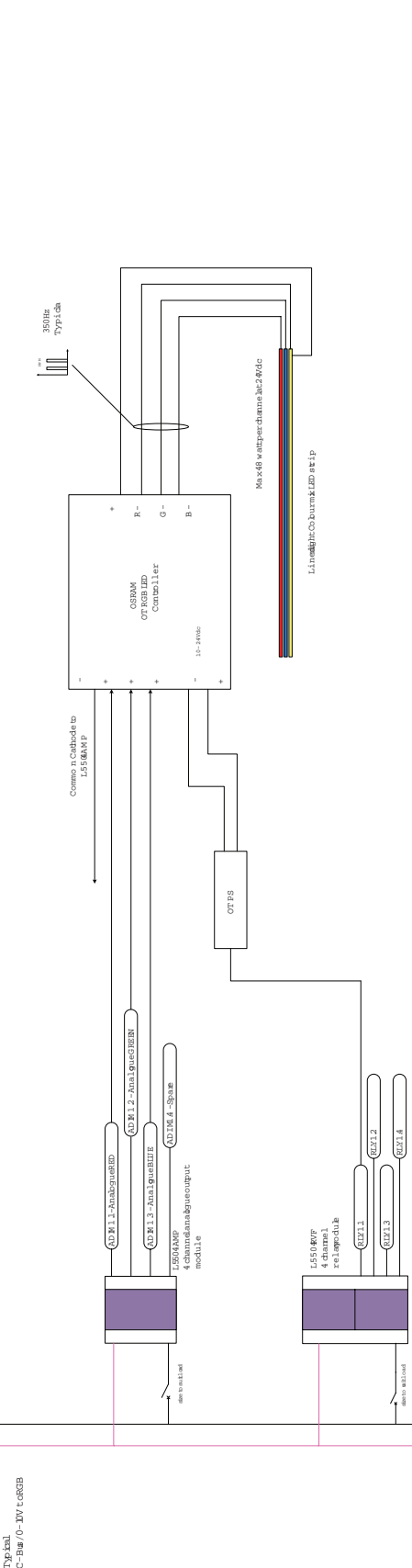
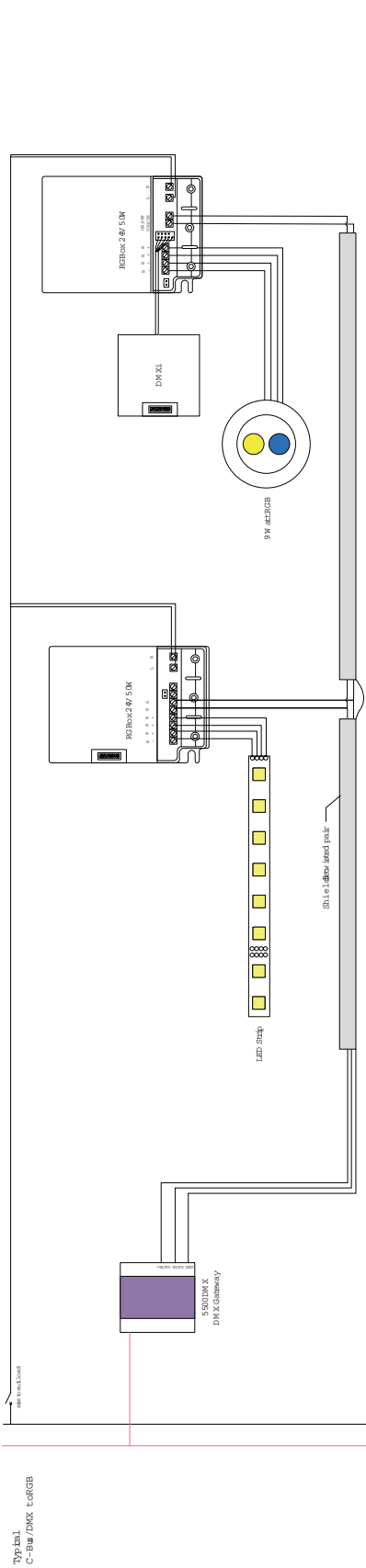

The DALI Ballasts are to be addressed with DALI commissioning software connected directly to the DALI Bus, not via the C-Bus commissioning software. This software, and any associated hardware, is best provided by the ballast manufacturer thus preventing warranty disputes in the event of incorrect ballast operation.

Clipsal C-Bus

Typical Schematics

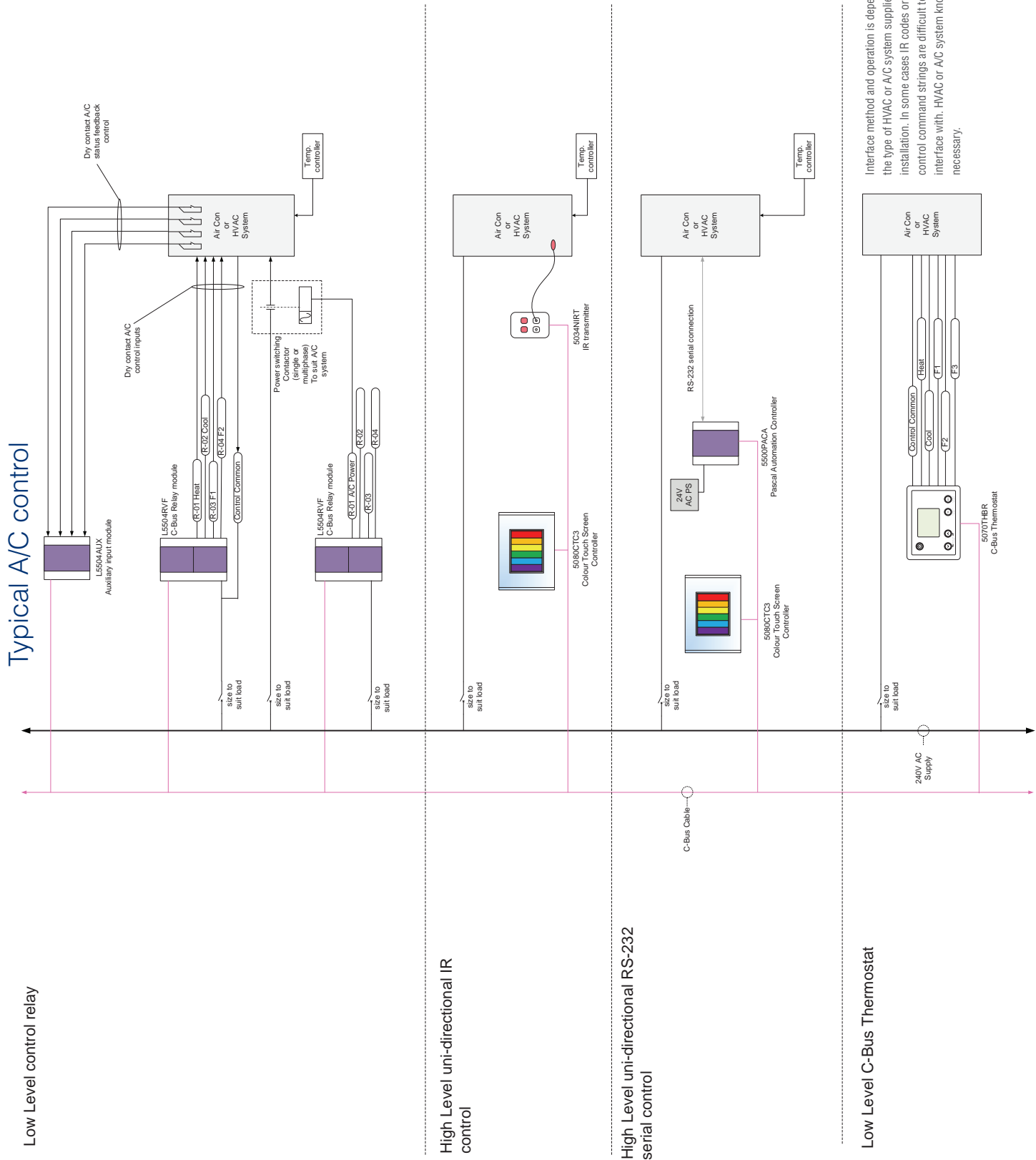

Interface method and operation is dependant on the type of HVAC or A/C system supplied to the installation. In some cases IR codes or RS-232 control command strings are difficult to obtain or interface with. HVAC or A/C system knowledge is necessary.

Typical Apartment Network

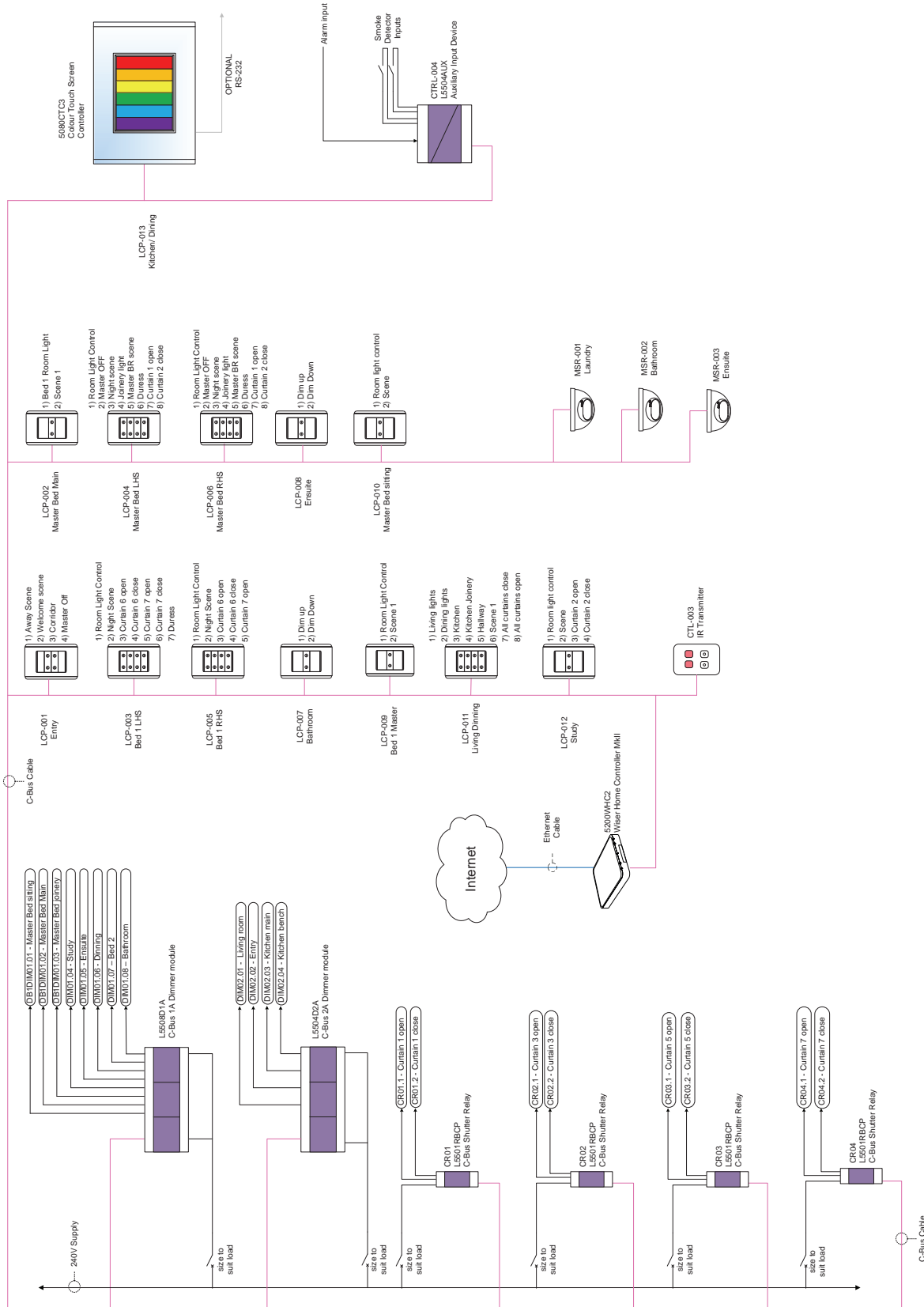

Clipsal C-Bus

Typical Schematics

Typical Office Network

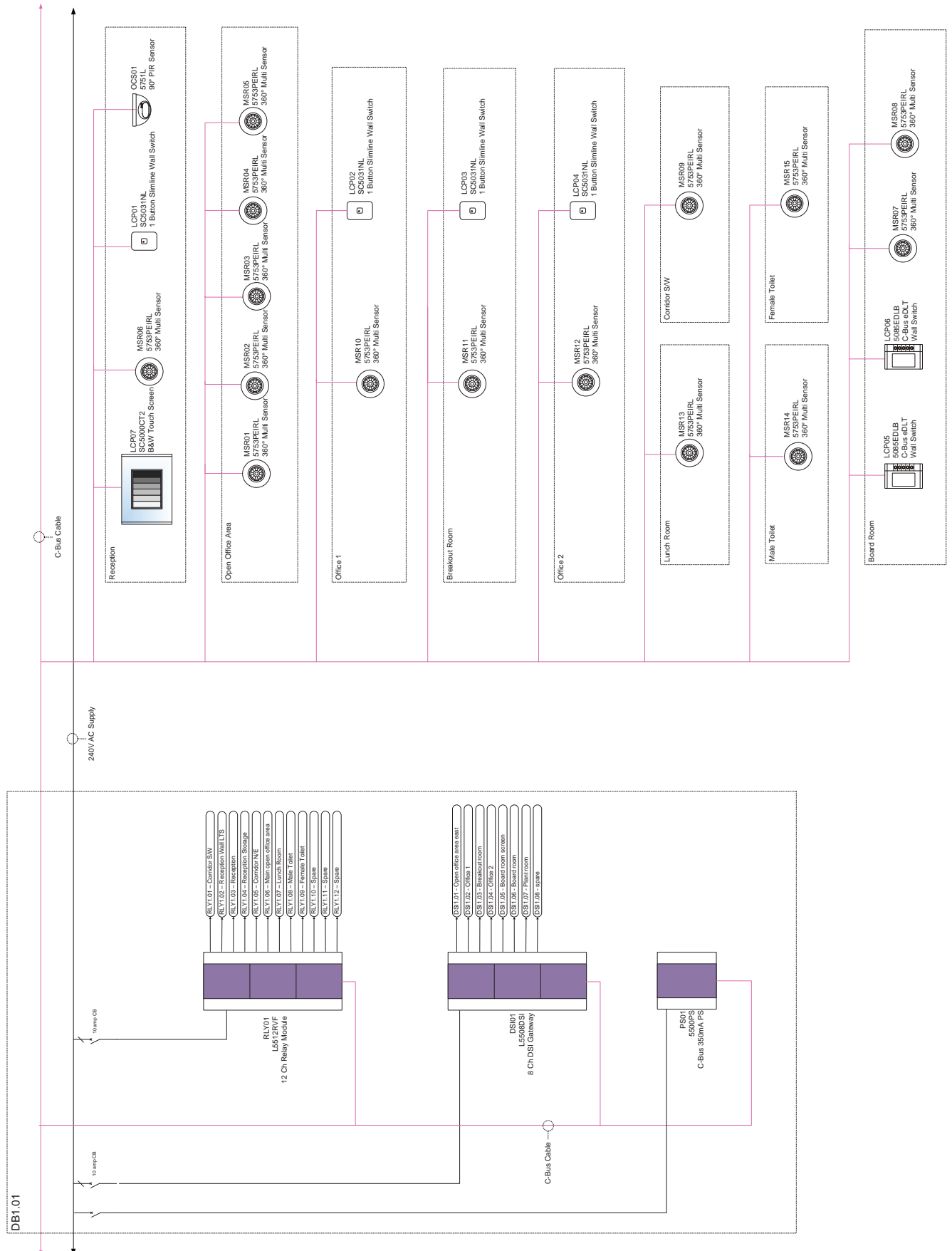

Clipsal C-Bus

Typical Schematics

Typical Audio Visual Integration

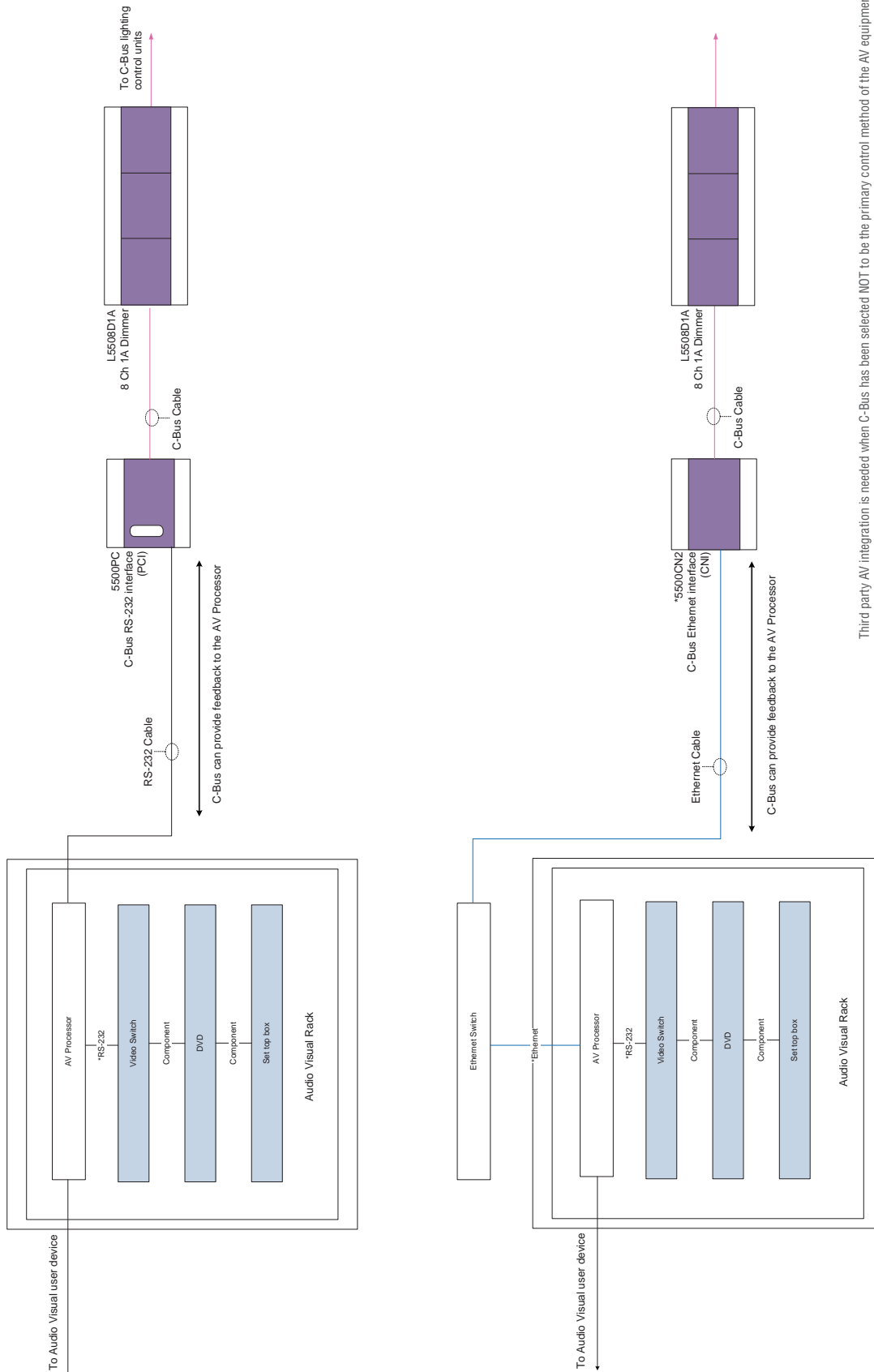

Third party AV integration is needed when C-Bus has been selected NOT to be the primary control method of the AV equipment. The third party AV equipment can communicate with C-Bus via: - A Clipsal PC Interface (PC1) using the RS232 protocol. - A Clipsal Network Interface (CNI) using TCP/IP. These connections will allow third party AV equipment to control C-Bus at a high level. The PC1 or CNI can be mounted within the Audio Visual rack, or alternately be located locally to the third party controller. Low level integration is possible with the use of Clipsal's L5108ELVP 8 Channel Extra Low Voltage Relay. *The 5500CN (CNI) is capable of utilising one TCP socket only at a time.

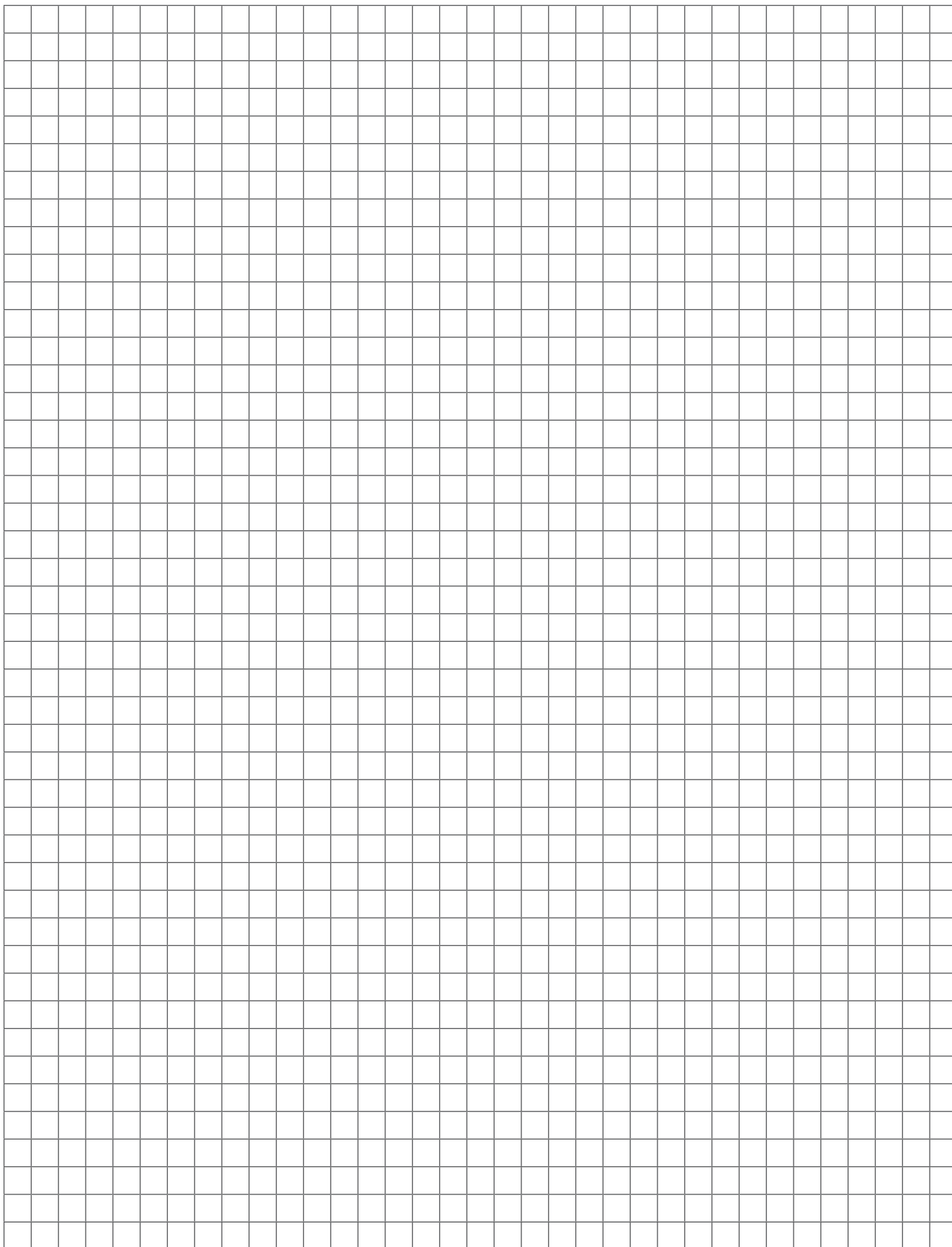

Schneider Electric (Australia) Pty Ltd

33-37 Port Wakefield Road, Gepps Cross,
South Australia 5094

PO Box 132, Enfield Plaza,
South Australia 5085

Telephone: (08) 8161 0511
Facsimile: (08) 8161 0900
Email: plugin@clipsal.com.au
Internet: www.clipsal.com

National Customer Care Enquiries:
1300 2025 25

National Customer Care Facsimile:
1300 2025 56

International Enquiries
International Sales and Marketing
Email: export@clipsal.com.au

Schneider Electric (NZ) Ltd
38 Business Parade South, Highbrook,
East Tamaki, Manukau 2013,
NEW ZEALAND

Telephone: + 64 9 829 0490
Facsimile: + 64 9 829 0491
Internet: www.schneider-electric.com

Customer Care
Freephone: 0800 652 999
Freefax: 0800 101 152
Email: sales@nz.schneider-electric.com
Internet: www.clipsal.co.nz

You can find this brochure and many others
online in PDF format at: **clipsal.com**

Follow the links off the home page or access
the following page directly:
clipsal.com/brochures

clipsal.com

Schneider Electric (Australia) Pty Ltd reserves the right
to change specifications, modify designs and discontinue
items without incurring obligation and whilst every effort is
made to ensure that descriptions, specifications and other
information in this catalogue are correct, no warranty is
given in respect thereof and the company shall not be liable
for any error therein.

© 2013 Schneider Electric. All Rights Reserved.
Trademarks are owned by Schneider Electric Industries
SAS or its affiliated companies.

This document has been printed using FSC Mix Certified paper.
ISO 14001 environmental management system in use at mill.